

Zhaoqing Ally Hardware Co., Limited



Aluminium
Hardware



Zhaoqing Ally Hardware Co., Ltd.

☎ Tel:+86-13660985666 +86-13760060088

✉ Email:Jane@allyhardware.net / info@allyhardware.net

🌐 www.allyhardware.com

📍 Add:Mu Mian Tou Zhujiang Village Jinli Town Gaoyao District Zhaoqing City 526105 Guangdong Province.

All rights reserved Print
March, 2023.



www.allyhardware.com



Mould room



Die-casting



Polishing room



Drilling workshop



Powder coating



Installation



Cnc workshop



Glass fitting workshop



Ally Hardware is a trusted global partner, successful elite teams in the security, time management and operation process control segment. It established in 2008, which specialized in aluminium window&door and glass door accessories, such as: window handle, window hinge, window roller, window lock, lock body and cylinder, door handle, door hinge, door lock, shower hinge, shower knob, waterproof, sliding door fitting, handrail fitting and so on.

- ◆ with 12600 square meters, 150 workers, 10QC, Automatic equipment, A complete line of production, After-sale service personnel in our factory
- ◆ exported to over 70 countries
- ◆ Accept OEM or ODM services
- ◆ provide professional design and solutions
- ◆ One-stop doors and Windows system solution provider
- ◆ Our vision: to improve value with quality and become the most trusted building materials partner.
- ◆ Our values: integrity, entrepreneurship and innovation, customer achievement, accuracy and realism



Content

To be your trusted building materials partner.

Convertirse en su socio de confianza en materiales de construcción.



ALLY PRODUCT RANGE

Aluminium window & door accessories
Glass door fittings
Balustrade hardware fittings

WELCOME TO JOIN US



Friction Stay Series
01-14



Window Operator Series
15



Window Handle Series
16-20



Multi-Point Handle Series
21-26



Crescent Lock Series
27-28



Door Handle Series
29-36



Lock Body Series
37-42



Flush Bolt Series
43-46



Window and Door Hinge Series
47-54



Sliding Lock Series
55-60



Window And Door Wheel Series
61-74



Sliding Door Handle Series
75-80



Corner Cleat Series
81-85



Wool Pile Series
86



Rubber Strips Series
87-90



Furniture Fitting Series
91



Protective Film And Tape Series
92



Aluminum Louver Shutter Series
93



19mm Round Groove S/S Friction Stay

Manufactured from high grade Austenitic stainless steel;
 Stainless steel-Engineering plastic slider for strength;
 Suitable for heavy side hung casement;
 Use Nylon pad to avoid friction between the support arms and make product more attractive and longer life.

(CHR Series) Aluminum window size				
Item No.	Window Height(mm)	Window Width(mm)	Window Weight(kg)	Open Degree
CHR10"	1500	400	14	90°
CHR12"	1500	500	16	90°
CHR14"	1500	550	18	90°
CHR16"	1500	600	22	90°
CHR18"	1500	650	24	90°
CHR20"	1600	700	26	65°

Installation Size(mm)									
Item No.	A	B	C	D	E	F	G	H	
CHR10"	39		183	183	39	207	261	433	
CHR12"	39		197	197	39	227	261	433	
CHR14"	39		229	229	36	253	265	433	
CHR16"	39		244	244	38	281	261	433	
CHR18"	40	118	258	258	34	248	261	433	
CHR20"	39	59	288	288	38	274	231	433	

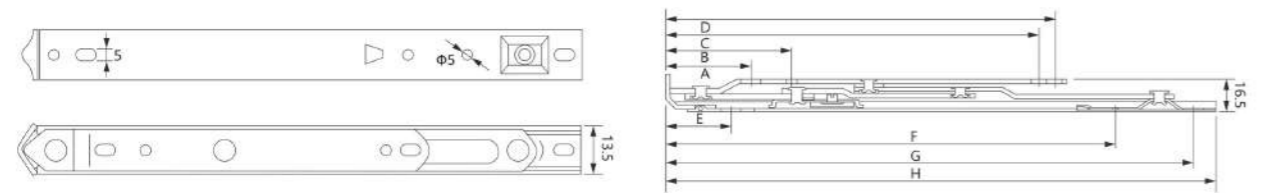

Safety Series Friction Stay

Manufactured from high grade Austenitic stainless steel;
 Built-in chind-resistant mechanism limits opening to a restricted position for safety and security purposes;
 Built-in quick release levers allow window to be fully opened for easy cleaning or emergency escape.

(CHRD Series) Aluminum window size				
Item No.	Window Height(mm)	Window Width(mm)	Window Weight(kg)	Open Degree
CHRD10"	1500	500	25	90°
CHRD12"	1500	600	30	90°
CHRD14"	1500	700	35	90°
CHRD16"	1500	750	40	90°

Installation Size(mm)									
Item No.	A	B	C	D	E	F	G	H	I
CHRD10"	41	60	176	190	30	110	125	268	288
CHRD12"	41	60	197	211	30	115	145	313	324
CHRD14"	41	115	230.5	244	30	100.5	141.5	362	372
CHRD16"	38	142	258	272	30	127.5	168.5	425	435

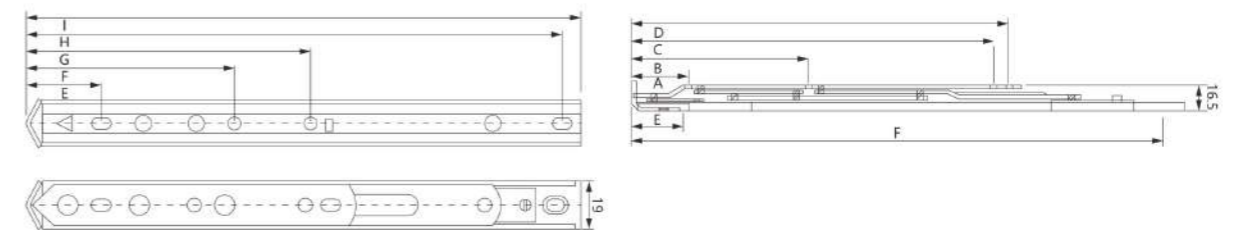



22mm Square Groove Heavy Duty Friction Stay

Manufactured from high grade Austenitic stainless steel;
Stainless steel-Engineering plastic slider for strength;
Suitable for heavy side hung casement;
Use Nylon pad to avoid friction between the support arms and make product more attractive and longer life;

(CHS Series) Aluminum window size				
Item No.	Window Height(mm)	Window Width(mm)	Window Weight(kg)	Open Degree
CHS10"	1500	500	20	90°
CHS12"	1500	600	24	90°
CHS14"	1500	700	27	90°
CHS16"	1500	750	31	90°
CHS18"	1500	800	34	90°
CHS20"	1800	900	36	85°

Installation Size(mm)										
Item No.	A	B	C	D	E	F	G	H	I	J
CHS10"	42	60	176	190	36	188			252	263
CHS12"	42	60	197	211	32	213	242		293	306
CHS14"	42	60	228	242	35	255	283		345	357
CHS16"	42	60	228	242	32	259	289		395	406
CHS18"	42	60	226	240	32	252	281		448	460
CHS20"	42	60	162	287	301	32	279	308	495	507

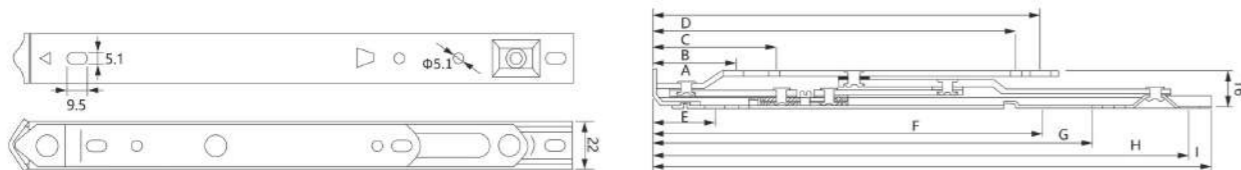

22mm Standard Friction Stay Heavy Duty For Top Hung

Manufactured from high grade Austenitic stainless steel;
Engineering-plastic slider for strength, durability and smooth operation;
Suitable for heavy duty top hung casement windows.

(CHST Series) Aluminum window size				
Item No.	Window Height(mm)	Window Width(mm)	Window Weight(kg)	Open Degree
CHST10"	600	1000	35	25° -30°
CHST12"	800	1200	45	25° -35°
CHST14"	1000	1200	55	25° -35°
CHST16"	1200	1200	65	25° -35°
CHST18"	1400	1500	80	30° -45°
CHST20"	1500	1500	100	30° -45°

Installation Size(mm)											
Item No.	A	B	C	D	E	F	G	H	I	J	K
CHST10"	37	94	139		35		187			254	263
CHST12"	37	82	109	154	33	176	205	242		294	306
CHST14"	37	82	155	199	35	46	313	340		346	357
CHST16"	37	82	179	224	32	44	228	257		394	406
CHST18"	37	82	196	241	32	223	252			448	460
CHST20"	37	82	214	258	303	36	247	276	454	508	520

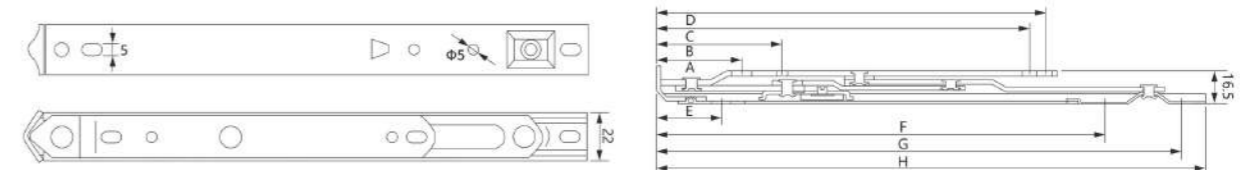



18mm Square Groove Heavy Duty Friction Stay

Manufactured from high grade Austenitic stainless steel;
 Stainless steel-Engineering plastic slider for strength;
 Suitable for heavy side hung casement;
 Use Nylon pad to avoid friction between the support arms and make product more attractive and longer life;

(CHS Series) Aluminum window size				
Item No.	Window Height(mm)	Window Width(mm)	Window Weight(kg)	Open Degree
CHS10"	1500	500	15	90°
CHS12"	1500	600	18	90°
CHS14"	1500	700	21	90°
CHS16"	1500	750	24	90°
CHS18"	1500	800	26	90°
CHS20"	1600	900	28	85°

Installation Size(mm)										
Item No.	A	B	C	D	E	F	G	H	I	J
CHS10"	36	49	175	188	33	195			251	263
CHS12"	36	49	190	203	33	202			297	309
CHS14"	36	82	227	240	333	233	265		337	350
CHS16"	36	82	227	240	33	227	261		397	407
CHS18"	36	82	235	249	33	241			446	460
CHS20"	36	50	197	304	318	30	231	433	508	507

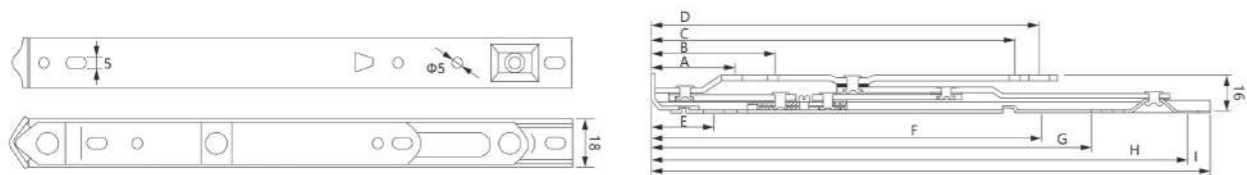

18mm Standard Friction Stay Heavy Duty For Top Hung

Manufactured from high grade Austenitic stainless steel, engineering-plastic slider for strength;
 Durability and smooth operation;
 Mainly used for light top projecting style domestic windows.
 It provides adequate friction at all opening angles.

(CHST Series) Aluminum window size				
Item No.	Window Height(mm)	Window Width(mm)	Window Weight(kg)	Open Degree
CHST10"	600	1000	21	25° -30°
CHST12"	750	1200	26	25° -35°
CHST14"	800	1200	28	25° -35°
CHST16"	850	1200	30	25° -35°
CHST18"	900	1300	35	30° -45°
CHST20"	1000	1400	40	30° -45°

Installation Size(mm)											
Item No.	A	B	C	D	E	F	G	H	I	J	K
CHST10"	37	94	139		35		187			254	263
CHST12"	37	82	109	154	33	176	205	242		294	306
CHST14"	37	82	155	199	35	46	313	340		346	357
CHST16"	37	82	179	224	32	44	228	257		394	406
CHST18"	37	82	196	241	32	223	252			448	460
CHST20"	37	82	214	258	303	36	247	276	454	508	520

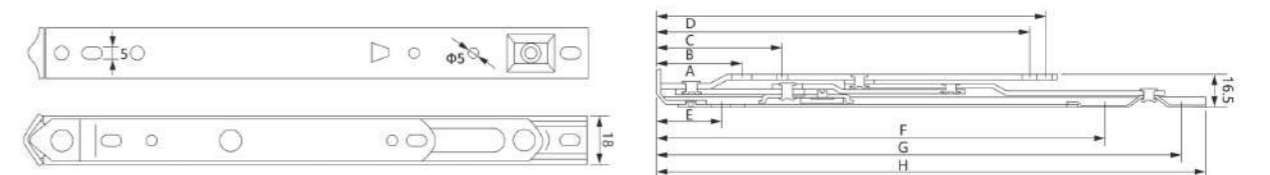



13.5mm Square Groove S/S Friction Stay

Manufactured from high grade Austenitic stainless steel;
 Stainless steel-Engineering plastic slider for strength;
 Suitable for heavy side hung casement;
 Use Nylon pad to avoid friction between the support arms and make product more attractive and longer life;

(CHS Series) Aluminum window size				
Item No.	Window Height(mm)	Window Width(mm)	Window Weight(kg)	Open Degree
CHS10"	1500	500	12	90°
CHS12"	1500	600	14	90°
CHS14"	1500	700	18	90°
CHS16"	1500	750	20	90°
CHS18"	1500	800	22	90°
CHS20"	1600	900	24	65°

Installation Size(mm)										
Item No.	A	B	C	D	E	F	G	H	I	J
CHS10"	36	49	175	188	33	195			251	259
CHS12"	36	49	190	203	33	202			297	305
CHS14"	36	82	227	240	333	233	265		337	346
CHS16"	36	82	227	240	33	227	261		395	405
CHS18"	36	82	235	249	33	241			446	456
CHS20"	36	50	197	304	318	30	231	433	508	503

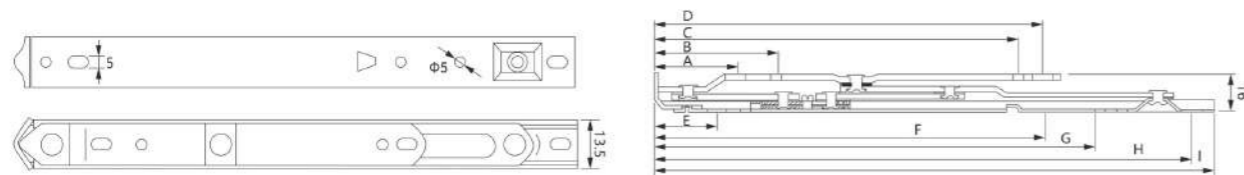

15mm Square Groove S/S Friction Stay

Manufactured from high grade Austenitic stainless steel;
 Stainless steel-Engineering plastic slider for strength;
 Suitable for heavy side hung casement;
 Use Nylon pad to avoid friction between the support arms and make product more attractive and longer life;

(CHS Series) Aluminum window size				
Item No.	Window Height(mm)	Window Width(mm)	Window Weight(kg)	Open Degree
CHS10"	1500	500	14	90°
CHS12"	1500	600	16	90°
CHS14"	1500	700	20	90°
CHS16"	1500	750	22	90°
CHS18"	1500	800	24	90°
CHS20"	1600	900	26	85°

Installation Size(mm)										
Item No.	A	B	C	D	E	F	G	H	I	J
CHS10"	36	49	175	188	33	195			251	259
CHS12"	36	49	190	203	33	202			297	305
CHS14"	36	82	227	240	333	233	265		337	346
CHS16"	36	82	227	240	33	227	261		397	405
CHS18"	36	82	235	249	33	241			446	456
CHS20"	36	50	197	304	318	30	231	433	508	503

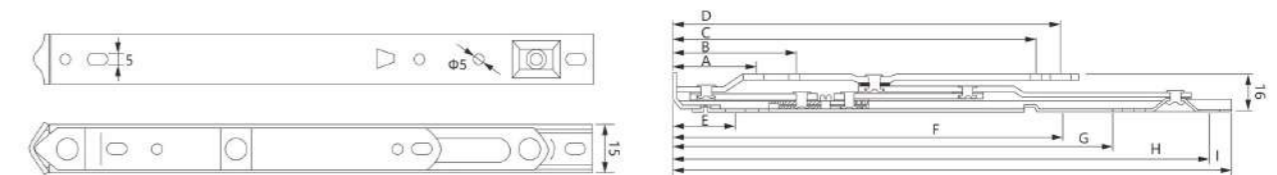



15mm Square Groove S/S Friction Stay

Manufactured from high grade Austenitic stainless steel;
Built-in chind-resistant mechanism limits opening to arestricted position for safety and security purposes;
Built-in quick release levers allow window to be fully opened for easy cleaning or emergency escape.

(CHS Series) Aluminum window size				
Item No.	Window Height(mm)	Window Width(mm)	Window Weight(kg)	Open Degree
CHS8"LR	800	500	12	65°
CHS10"LR	1000	550	14	90°
CHS12"LR	1200	600	16	90°
CHS14"LR	1200	600	18	90°
CHS16"LR	1200	600	20	90°
CHS20"LR	1200	800	24	65°

Installation Size(mm)								
Item No.	A	B	C	D	E	F	G	H
CHS8"LR	42		145	156	31	156	265	433
CHS10"LR	39		183	183	39	207	261	433
CHS12"LR	39		197	197	39	227	261	433
CHS14"LR	39		229	229	36	253	265	433
CHS16"LR	39		244	244	38	281	261	433
CHS20"LR	40	118	258	258	34	248	261	433

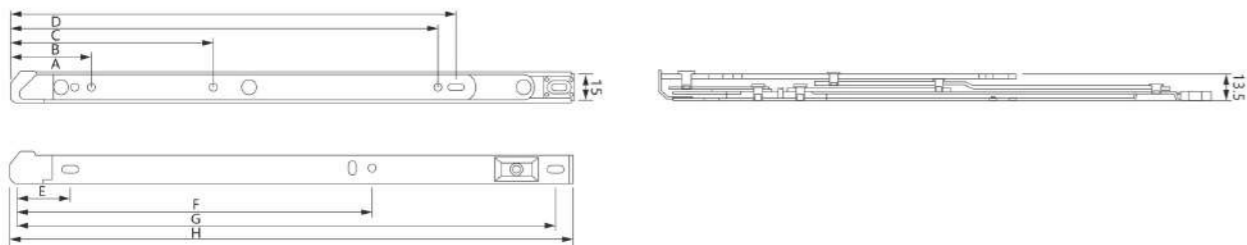

18mm Square Groove S/S Friction Stay

Manufactured from high grade Austenitic stainless steel;
Built-in chind-resistant mechanism limits opening to arestricted position for safety and security purposes;
Built-in quick release levers allow window to be fully opened for easy cleaning or emergency escape.

(CHS Series) Aluminum window size				
Item No.	Window Height(mm)	Window Width(mm)	Window Weight(kg)	Open Degree
CHS8"LR	800	500	14	65°
CHS10"LR	1000	550	16	90°
CHS12"LR	1200	600	18	90°
CHS14"LR	1200	600	20	90°
CHS16"LR	1200	600	22	90°
CHS20"LR	1200	800	26	65°

Installation Size(mm)								
Item No.	A	B	C	D	E	F	G	H
CHS8"LR	42		145	156	31	156	265	433
CHS10"LR	39		183	183	39	207	261	433
CHS12"LR	39		197	197	39	227	261	433
CHS14"LR	39		229	229	36	253	265	433
CHS16"LR	39		244	244	38	281	261	433
CHS20"LR	40	118	258	258	34	248	261	433

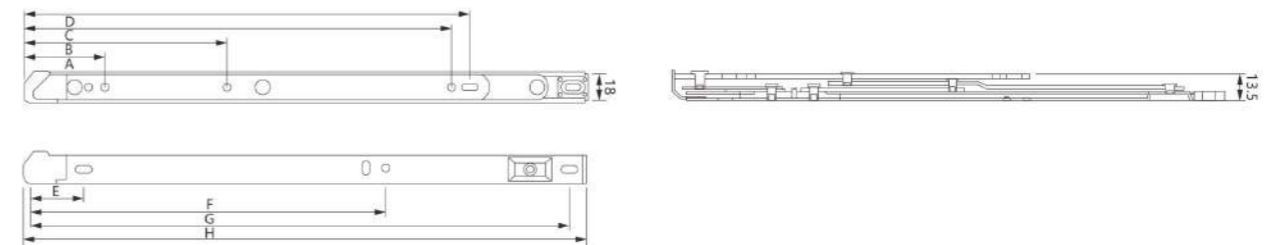

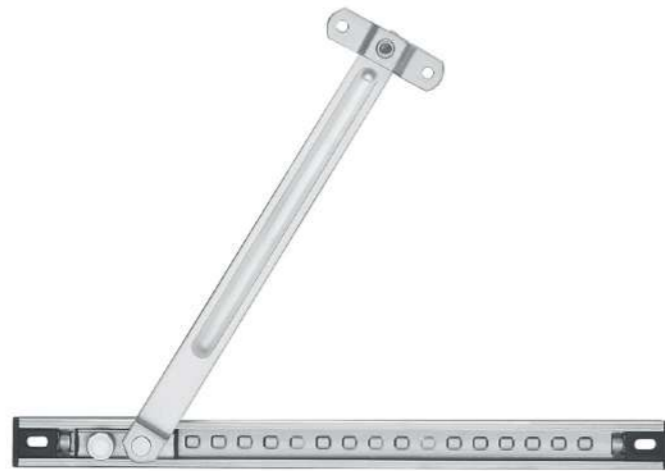

18mm Square Groove S/S Two Bar Hinges

Manufactured from high grade Austenitic stainless steel; It can be used as extra support for large top hung vents, efficient for limiting opening angle and great stability to the window.

Installation Size(mm)				
S/N	Item No.	A	B	C
1	CHS8"	210	187	120
2	CHS10"	258	235	174
3	CHS12"	301	277	214
4	CHS14"	353	329	258
5	CHS16"	402	380	314

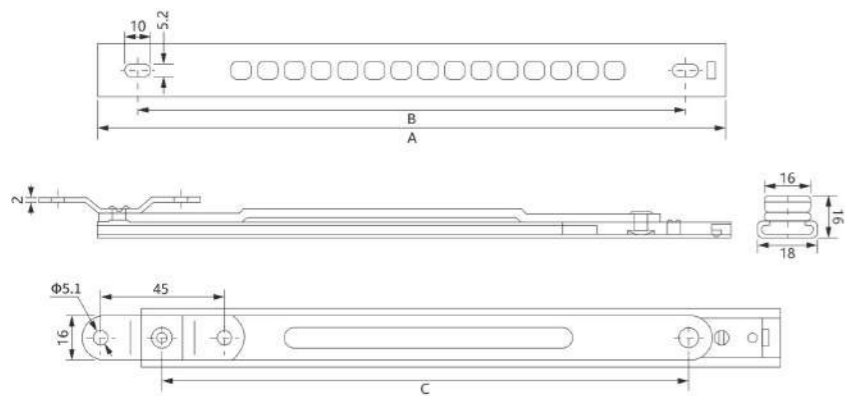

19mm Round Groove S/S Two Bar Hinges

Manufactured from high grade Austenitic stainless steel; It can be used as extra support for large top hung vents, efficient for limiting opening angle and great stability to the window.

Installation Size(mm)				
S/N	Item No.	A	B	C
1	CHR8"	205	184	155
2	CHR10"	255	235	175
3	CHR12"	293	273	221
4	CHR14"	343	328	261
5	CHR16"	400	382	320

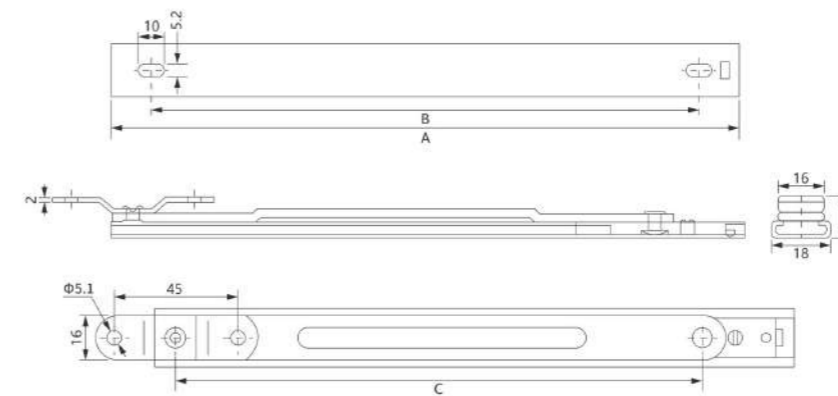



22mm Square Groove S/S Two Bar Hinges

Manufactured from high grade Austenitic stainless steel; It can be used as extra support for large top hung vents, efficient for limiting opening angle and great stability to the window.

Installation Size(mm)				
S/N	Item No.	A	B	C
1	CHS8"	209	188	137
2	CHS10"	258	236	190
3	CHS12"	304	283	230
4	CHS14"	345	327	275
5	CHS16"	404	383	330

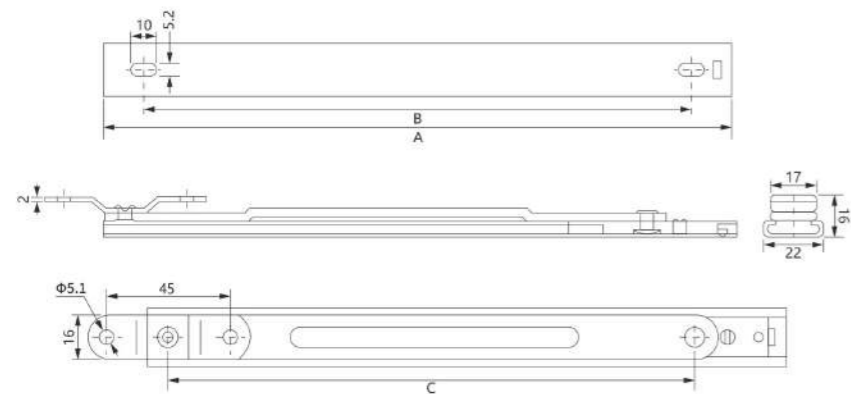

CHE Series S/S Automatically Locked Hinge

Manufacture from high grade Austenitic stainless steel; It mainly used for top hung window, automatically locked at a certain setting position; When close the window, simply lift the sash slightly then close.

Technical Data(mm)			
S/N	Item No.	A	B
1	CHE8"	204	155
2	CHE10"	303	204
3	CHE12"	404	354
4	CHE14"	504	304

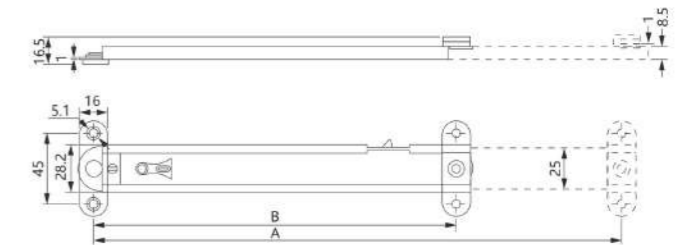

CHE Series S/S Automatically Locked Hinge

Manufacture from high grade Austenitic stainless steel; It mainly used for top hung window, it can be positioned at five different opening angle. When close the window, open to its maximum angle and then closed. It's automatically locked at a certain setting position; When close the window, simply lift the sash slightly then close.

Technical Data(mm)			
S/N	Item No.	A	B
1	CHE8"	273	208
2	CHE10"	365	256
3	CHE12"	456	305

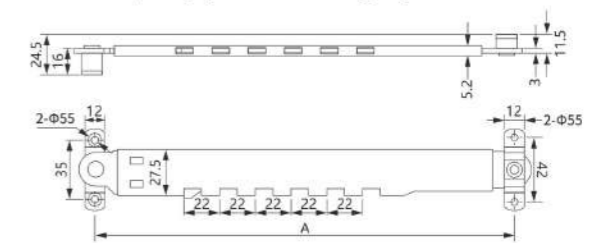

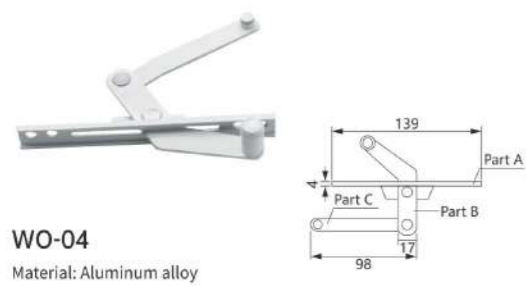
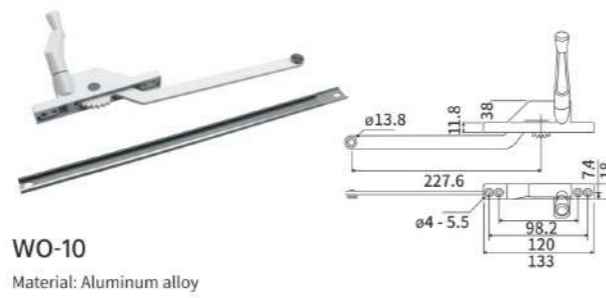
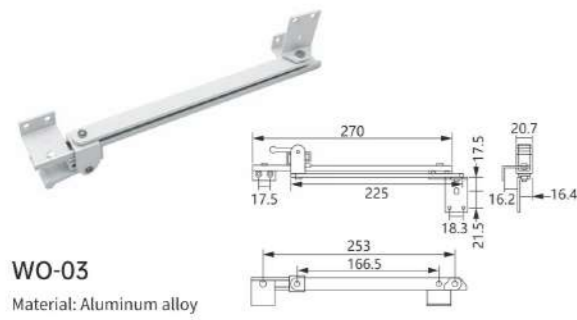
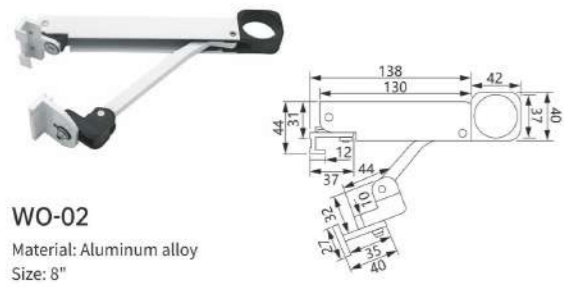

Window Handle

- Security defender
- Easy to install
- Durable and economic
- Available in aluminium alloy material





HL-11 (Screw Type)

Type: Left hand and right hand available
 Material: Aluminum alloy
 Finish: Powder coating, Oil injection
 Colour: Black, White, Silver, Brown, Beige, Champagne

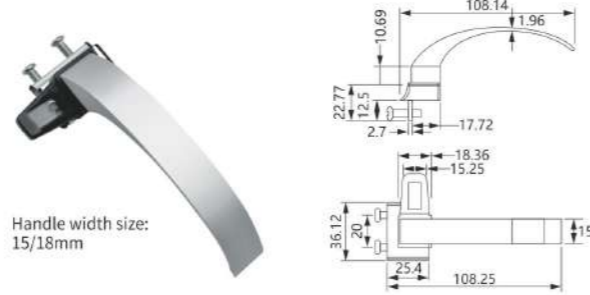

HL-15

Handle width size: 15/18mm
 Finish: Powder coating, Oil injection
 Material: Aluminum
 Colour: Black, White, Silver, Brown, Beige, Champagne

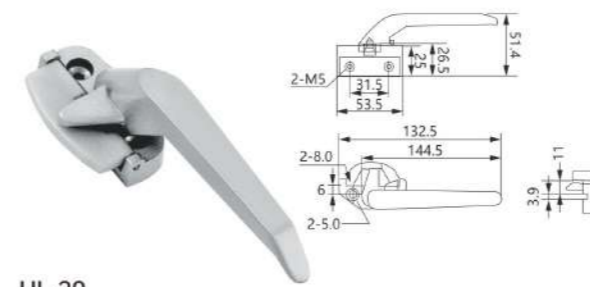

HL-20

Type: Left hand and right hand available
 Material: Aluminum alloy
 Finish: Powder coating, Oil injection
 Colour: Black, White, Silver, Brown, Beige, Champagne



HL-24

Type: Left hand and right hand available
 Material: Aluminum alloy
 Finish: Powder coating, Oil injection
 Colour: Black, White, Silver, Brown, Beige, Champagne



HL-11-2 (Plastic Type)

Type: Left hand and right hand available
 Material: Plastic
 Colour: Black, White, Silver, Brown, Beige, Champagne

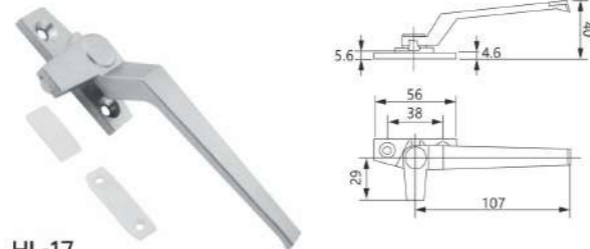

HL-17

Type: Left hand and right hand available
 Material: Aluminum alloy
 Finish: Powder coating, Oil injection
 Colour: Black, White, Silver, Brown, Beige, Champagne

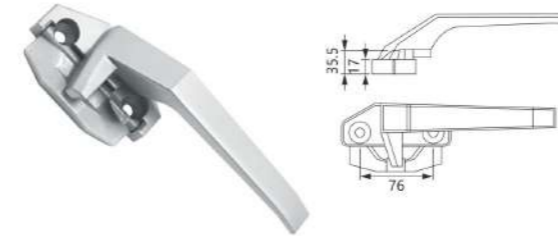

HL-20-2

Type: Left hand and right hand available
 Material: Aluminum alloy
 Finish: Powder coating, Oil injection
 Colour: Black, White, Silver, Brown, Beige, Champagne

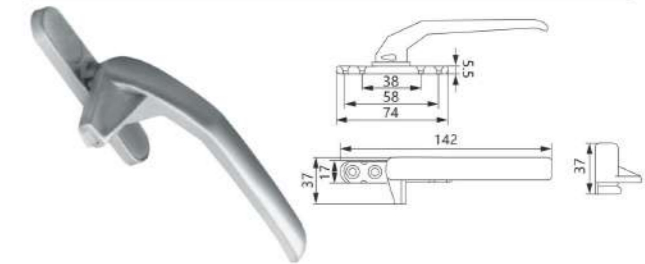

HL-26 (Plastic Type)

Type: Left hand and right hand available
 Material: Aluminum alloy
 Finish: Powder coating, Oil injection
 Colour: Black, White, Silver, Brown, Beige, Champagne



HL-12 (Rivet Type)

Type: Left hand and right hand available
 Material: Aluminum alloy
 Finish: Powder coating, Oil injection
 Colour: Black, White, Silver, Brown, Beige, Champagne

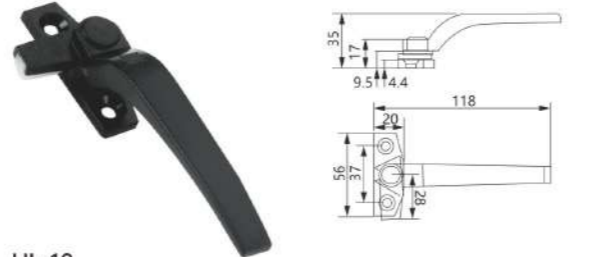

HL-18

Type: Left hand and right hand available
 Material: Aluminum alloy
 Finish: Powder coating, Oil injection
 Colour: Black, White, Silver, Brown, Beige, Champagne



HL-21

Type: Left hand and right hand available
 Material: Aluminum alloy
 Finish: Powder coating, Oil injection
 Colour: Black, White, Silver, Brown, Beige, Champagne

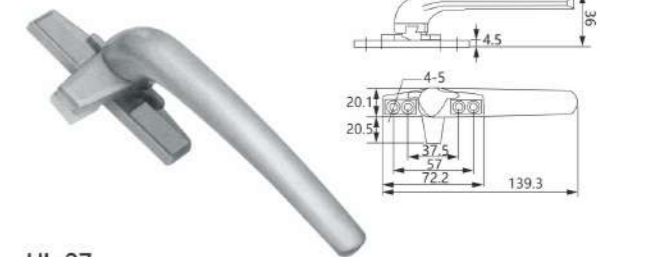

HL-27

Type: Left hand and right hand available
 Material: Zinc alloy
 Finish: Powder coating, Oil injection
 Colour: Black, White, Silver, Brown, Beige, Champagne



HL-14

Type: Left hand and right hand available
 Material: Aluminum alloy
 Finish: Powder coating, Oil injection
 Colour: Black, White, Silver, Brown, Beige, Champagne



HL-19

Type: Left hand and right hand available
 Material: Aluminum alloy
 Finish: Powder coating, Oil injection
 Colour: Black, White, Silver, Brown, Beige, Champagne

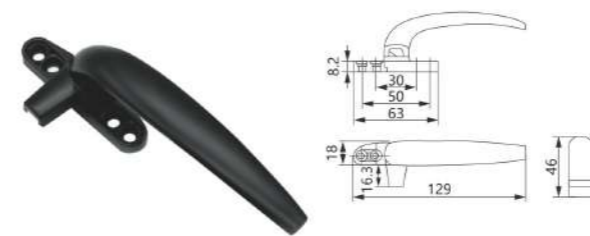

HL-22

Type: Left hand and right hand available
 Material: Aluminum alloy
 Finish: Powder coating, Oil injection
 Colour: Black, White, Silver, Brown, Beige, Champagne

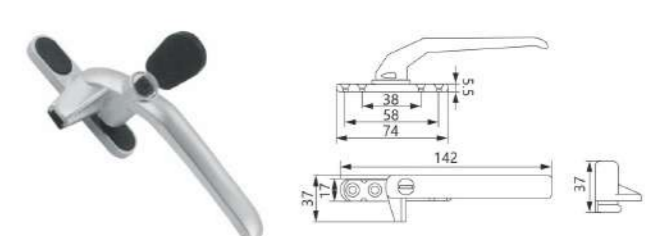

HL-28

Type: Left hand and right hand available
 Material: Aluminum alloy/Zinc alloy
 Finish: Powder coating, Oil injection
 Colour: Black, White, Silver, Brown, Beige, Champagne

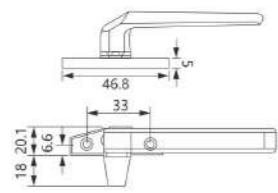

HL-31
Type: Left hand and right hand available
Material: Aluminum alloy
Finish: Powder coating, Oil injection
Colour: Black, White, Silver, Brown, Beige, Champagne



HL-41
Type: Left hand and right hand available
Material: Aluminum alloy
Finish: Powder coating, Oil injection
Colour: Black, White, Silver, Brown, Beige, Champagne

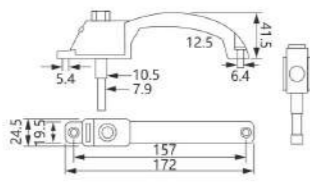

HL-38
Material: Aluminum alloy
Finish: Powder coating, Oil injection
Colour: Black, White, Silver, Brown, Beige, Champagne



HL-42 (81/92/110g)
Type: Left hand and right hand available
Material: Aluminum alloy
Finish: Powder coating, Oil injection
Colour: Black, White, Silver, Brown, Beige, Champagne

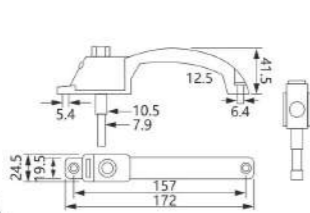

HL-39
Material: Aluminum alloy
Finish: Powder coating, Oil injection
Colour: Black, White, Silver, Brown, Beige, Champagne

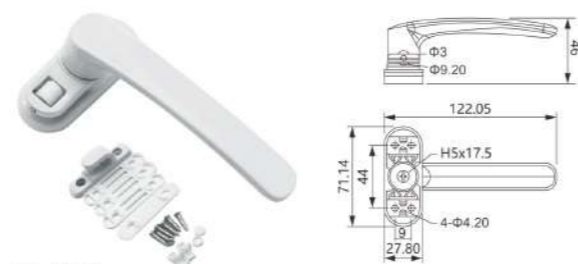

HL-42C
Type: Left hand and right hand available
Material: Aluminum alloy
Finish: Powder coating, Oil injection
Colour: Black, White, Silver, Brown, Beige, Champagne

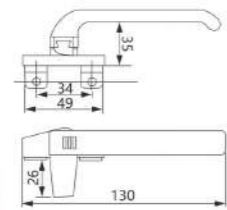

HL-40
Type: Left hand and right hand available
Material: Aluminum alloy
Finish: Powder coating, Oil injection
Colour: Black, White, Silver, Brown, Beige, Champagne



HL-43
Type: Left hand and right hand available
Material: Aluminum alloy
Finish: Powder coating, Oil injection
Colour: Black, White, Silver, Brown, Beige, Champagne



HL-44A
Type: Left hand and right hand available
Material: Aluminum alloy
Finish: Powder coating, Oil injection
Colour: Black, White, Silver, Brown, Beige, Champagne



HL-69
Material: Plastic
Colour: Black, White, Silver



HL-60
Material: Aluminum
Finish: Powder coating, Oil injection
Colour: Black, White, Silver, Brown, Beige, Champagne



HL-82
Type: Left hand and right hand available
Material: Aluminum alloy
Finish: Powder coating, Oil injection
Colour: Black, White, Silver, Brown, Beige, Champagne



HL-60-1
Material: Aluminum
Finish: Powder coating, Oil injection
Colour: Black, White, Silver, Brown, Beige, Champagne

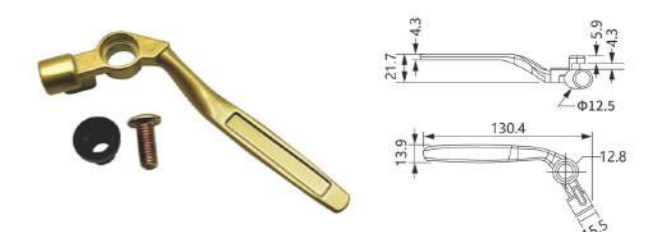

HL-83
Type: Left hand and right hand available
Material: Aluminum alloy
Finish: Powder coating, Oil injection
Colour: Black, White, Silver, Brown, Beige, Champagne



HL-63
Material: Plastic
Colour: Black, White, Silver



HL-85
Type: Left hand and right hand available
Material: Aluminum alloy
Finish: Powder coating, Oil injection
Colour: Black, White, Silver, Brown, Beige, Champagne

Item No.: WH-26

Multipoint Lock For Slot Outer Opening

The length of standard transmission rod is flexible in 400, 600, 800, 1000, 1200, 1400 and 1800mm;
Transmission rod with special specification can be made as per your request.

Multipoint Lock For Slot Outer Opening			
S/N	Description	Item No.	Quantity
1	Multipoint handle	WH-26	1
2	Transmission bar		1
3	Lock seat		2



Double fork

Single fork



Item No.: WH-14

Multipoint Lock For Casement Window

The length of standard transmission rod is flexible in 400, 600, 800, 1000, 1200, 1400 and 1800mm;
Transmission rod with special specification can be made as per your request.

Multipoint Lock For Casement Window			
S/N	Description	Item No.	Quantity
1	Multipoint handle	WH-14	1
2	Transmission bar		1
3	Lock seat		2





WH-12
Material: Aluminum alloy
Finish: Powder coating, Oil injection
Colour: Black, White, Silver, Brown, Beige



WH-17
Material: Zinc alloy bottom+Aluminum alloy handle
Finish: Powder coating, Oil injection
Colour: Black, White, Silver, Brown, Beige



WH-13
Material: Zinc alloy bottom+Aluminum alloy handle/ Aluminum alloy
Finish: Powder coating, Oil injection
Colour: Black, White, Silver, Brown, Beige, Champagne

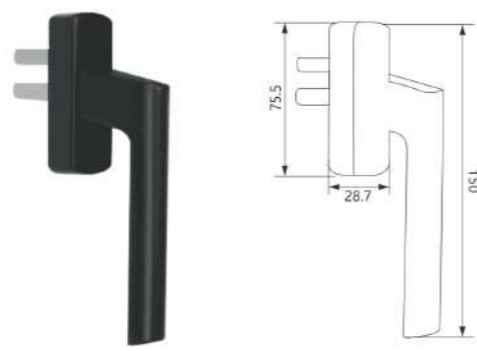

WH-18
Material: Aluminum alloy
Finish: Powder coating, Oil injection
Colour: Black, White, Silver, Brown, Beige, Champagne



WH-14
Material: Zinc alloy bottom+Aluminum alloy handle
Finish: Powder coating, Oil injection
Colour: Black, White, Silver, Brown, Beige



WH-19
Material: Aluminum alloy
Finish: Powder coating, Oil injection
Colour: Black, White, Silver, Brown, Beige



WH-20
Material: Aluminum alloy
Finish: Powder coating, Oil injection
Colour: Black, White, Silver, Brown, Beige

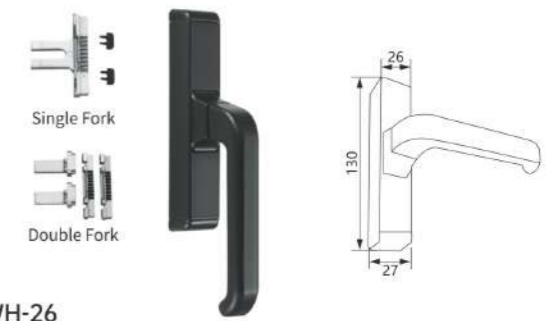

WH-26
Material: Zinc alloy bottom+Aluminum alloy handle/ All aluminum alloy
Finish: Powder coating, Oil injection
Colour: Black, White, Silver, Brown, Beige



WH-22
Material: Zinc alloy bottom+Aluminum alloy handle
Finish: Powder coating, Oil injection
Colour: Black, White, Silver, Brown, Beige



WH-28
Material: Aluminum alloy
Finish: Powder coating, Oil injection
Colour: Black, White, Silver, Brown, Beige



WH-23
Material: Zinc alloy bottom+Aluminum alloy handle
Finish: Powder coating, Oil injection
Colour: Black, White, Silver, Brown, Beige



WH-35
Material: Aluminum alloy
Finish: Powder coating, Oil injection
Colour: Black, White, Silver, Brown, Beige



WH-25
Material: Aluminum alloy
Finish: Powder coating, Oil injection
Colour: Black, White, Silver, Brown, Beige

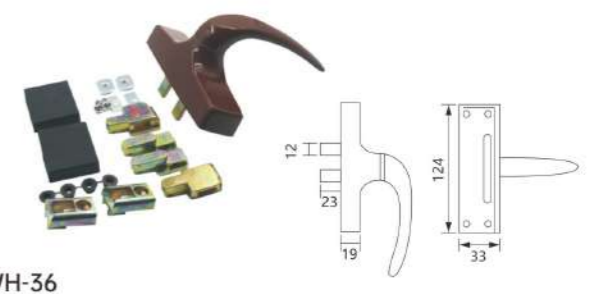

WH-36
Material: Aluminum alloy
Finish: Powder coating, Oil injection
Colour: Black, White, Silver, Brown, Beige

UPVC Hardware

- ◉ Security defender
- ◉ Easy to install
- ◉ Durable and economic
- ◉ Available in aluminium alloy material



WH-01
Material: Aluminum alloy
Finish: Powder coating, Oil injection
Colour: Black, White, Silver, Brown, Beige

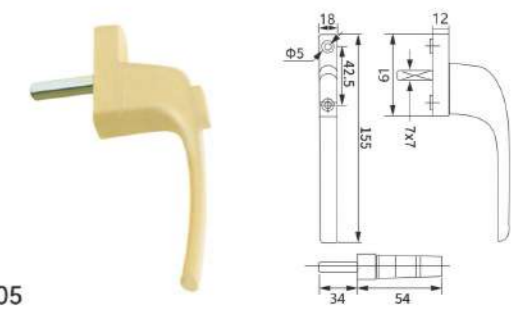

WH-05
Material: Aluminum alloy
Finish: Powder coating, Oil injection
Colour: Black, White, Silver, Brown, Beige

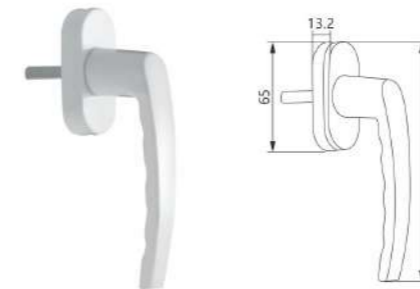

WH-02
Material: Aluminum alloy
Finish: Powder coating, Oil injection
Colour: Black, White, Silver, Brown, Beige

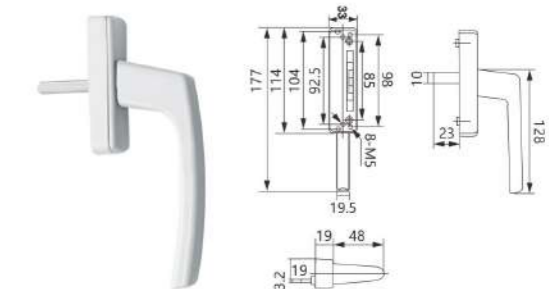

WH-06
Material: Aluminum alloy
Finish: Powder coating, Oil injection
Colour: Black, White, Silver, Brown, Beige

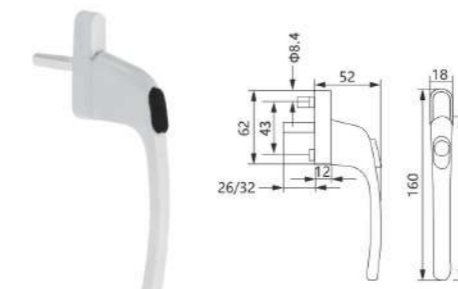

WH-03
Material: Aluminum alloy
Finish: Powder coating, Oil injection
Colour: Black, White, Silver, Brown, Beige



WH-08
Material: Aluminum alloy
Finish: Powder coating, Oil injection
Colour: Black, White, Silver, Brown, Beige



WH-04
Material: Aluminum alloy
Finish: Powder coating, Oil injection
Colour: Black, White, Silver, Brown, Beige

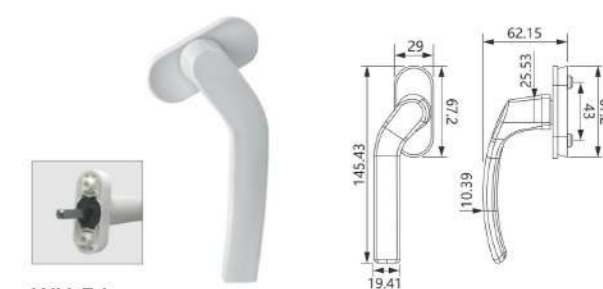

WH-34
Material: Aluminum alloy
Finish: Powder coating, Oil injection
Colour: Black, White, Silver, Brown, Beige

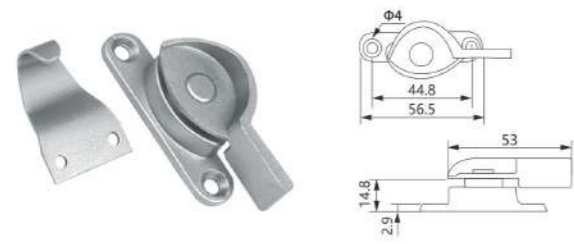

CL-01
Material: Aluminum alloy
Finish: Powder coating, Oil injection
Colour: Black, White, Silver, Brown



CL-06A
Hook Size: 38/42/44/52mm
Material: Aluminum alloy
Finish: Powder coating, Oil injection
Colour: Black, White, Silver, Brown



CL-02 (with iron hook)
Material: Zinc alloy
Finish: Powder coating, Oil injection
Colour: Black, White, Silver, Brown



CL-07
Material: Aluminum alloy
Finish: Powder coating, Oil injection
Colour: Black, White, Silver, Brown



CL-04 (with SS201 hook)
Material: Aluminum alloy
Finish: Powder coating, Oil injection
Colour: Black, White, Silver, Brown, Beige



CL-08
Material: Aluminum alloy
Finish: Powder coating, Oil injection
Colour: Black, White, Silver, Brown

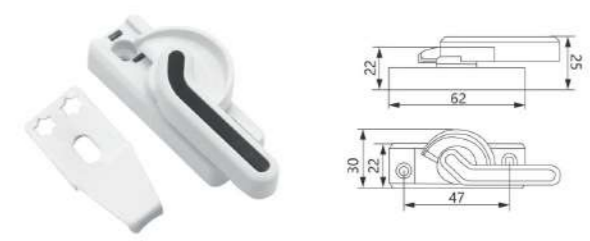

WH-05 (with iron hook)
Material: Aluminum alloy
Finish: Powder coating, Oil injection
Colour: Black, White, Silver, Brown

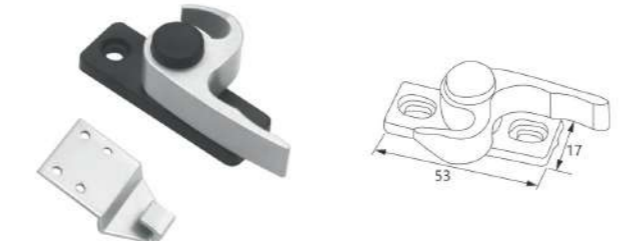

CL-09 (with aluminum hook)
Material: Aluminum + Plastic
Finish: Powder coating, Oil injection, Anodized
Colour: Black, White, Silver, Brown, Beige



CL-09C
Material: Aluminum + Plastic
Finish: Powder coating, Oil injection, Anodized
Colour: Black, White, Silver, Brown, Champagne



CL-11 (with iron hook)
Material: Aluminum alloy
Finish: Powder coating, Oil injection
Colour: Black, White, Silver, Brown



CL-09D (with iron hook)
Material: Plastic
Finish: Powder coating, Oil injection
Colour: Black, White, Silver, Brown

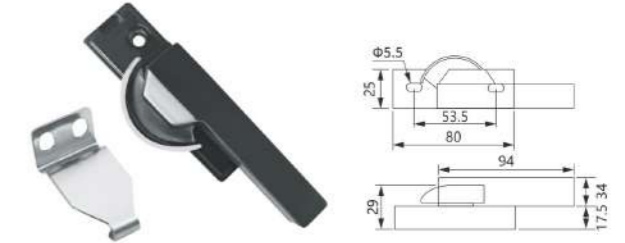

CL-13 (with SS201 hook)
Material: Zinc alloy
Finish: Powder coating, Oil injection
Colour: Black, White, Silver, Brown



CL-09F (with aluminum hook)
Material: Aluminum + Plastic
Finish: Powder coating, Oil injection, Anodized
Colour: Black, White, Silver, Brown, Beige, Champagne



CL-15 (with SS201 hook)
Material: Zinc alloy
Finish: Powder coating, Oil injection
Colour: Black, White, Silver, Brown

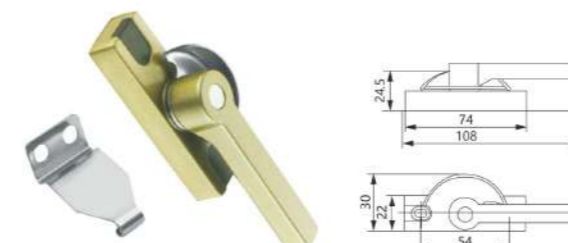

CL-10 (with SS201 hook)
Material: Aluminum alloy/Zinc alloy
Finish: Powder coating, Oil injection
Colour: Black, White, Silver, Brown



CL-17 (with iron hook)
Material: Aluminum alloy
Finish: Powder coating, Oil injection
Colour: Black, White, Silver, Brown

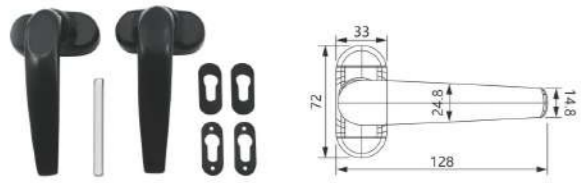

HL-01
Material: Aluminum alloy
Finish: Powder coating, Oil injection
Colour: Black, White, Silver, Brown, Beige, Champagne

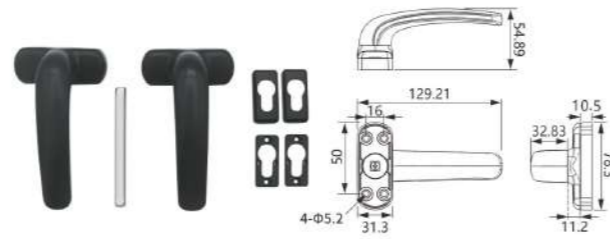

HL-09B
Material: Aluminum alloy
Finish: Powder coating, Oil injection
Colour: Black, White, Silver, Brown, Beige, Champagne



HL-34
Material: Aluminum
Finish: Powder coating, Oil injection
Colour: Black, White, Silver, Brown, Beige, Champagne



HL-35
Material: Aluminum alloy
Finish: Powder coating, Oil injection
Colour: Black, White, Silver, Brown, Beige, Champagne

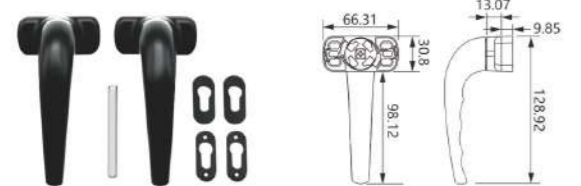

HL-03
Material: Zinc alloy
Finish: Powder coating, Oil injection
Colour: Black, White, Silver, Brown, Beige, Champagne

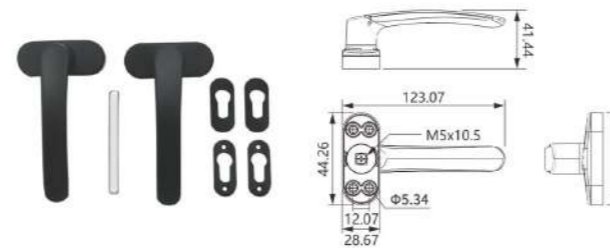

HL-09C
Material: Aluminum alloy
Finish: Powder coating, Oil injection
Colour: Black, White, Silver, Brown, Beige, Champagne



HL-47
Material: Aluminum
Finish: Powder coating, Oil injection
Colour: Black, White, Silver, Brown, Beige, Champagne



HL-47-1
Material: Aluminum
Finish: Powder coating, Oil injection
Colour: Black, White, Silver, Brown, Beige, Champagne

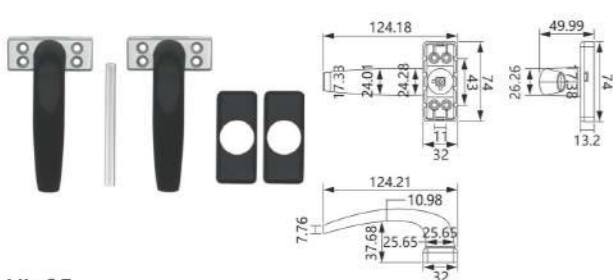

HL-05
Material: Aluminum alloy
Finish: Powder coating, Oil injection
Colour: Black, White, Silver, Brown, Beige, Champagne

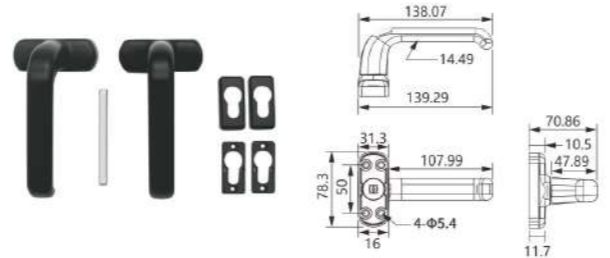

HL-09D
Material: Aluminum alloy
Finish: Powder coating, Oil injection
Colour: Black, White, Silver, Brown, Beige, Champagne



HL-48 (1.0mm thickness)
Material: Aluminum
Finish: Powder coating, Oil injection
Colour: Black, White, Silver, Brown, Beige, Champagne



HL-45
Material: Aluminum
Finish: Powder coating, Oil injection, Anodized
Colour: Black, White, Silver, Brown, Beige, Champagne, Charcoal



HL-09
Material: Aluminum alloy
Finish: Powder coating, Oil injection
Colour: Black, White, Silver, Brown, Beige, Champagne

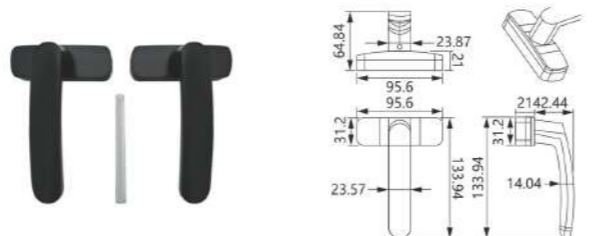

HL-09E
Material: Aluminum alloy
Finish: Powder coating, Oil injection
Colour: Black, White, Silver, Brown, Beige, Champagne



HL-48A (0.6mm thickness)
Material: Aluminum
Finish: Powder coating, Oil injection
Colour: Black, White, Silver, Brown, Beige, Champagne

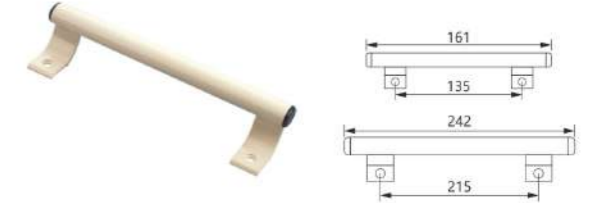

HL-46
Material: Aluminum
Size: 7" / 10"
Finish: Powder coating, Oil injection
Colour: Black, White, Silver, Brown, Beige, Champagne

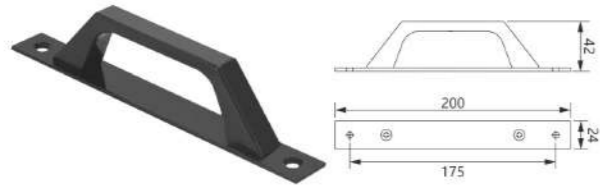

HL-49
Material: Aluminum
Finish: Powder coating, Oil injection
Colour: Black, White, Silver, Brown, Beige, Champagne



HL-66
Material: Aluminum
Finish: Powder coating, Oil injection
Colour: Black, White, Silver, Brown, Beige, Champagne

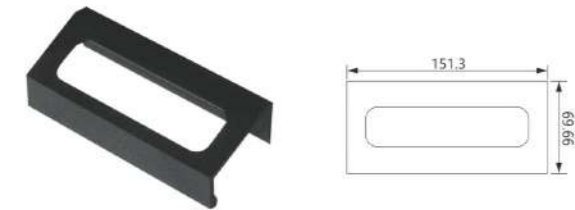

HL-50
Material: Aluminum
Finish: Powder coating, Oil injection
Colour: Black, White, Silver, Brown, Beige, Champagne



HL-62
Material: Zinc alloy
Finish: Powder coating, Oil injection
Colour: Black, White, Silver, Brown, Beige, Champagne



HL-51
Material: Aluminum
Finish: Powder coating, Oil injection
Colour: Black, White, Silver, Brown, Beige, Champagne



HL-76
Material: Aluminum alloy
Finish: Powder coating, Oil injection
Colour: Black, White, Silver, Brown, Beige, Champagne



HL-51-1
Material: Aluminum
Finish: Powder coating, Oil injection
Colour: Black, White, Silver, Brown, Beige, Champagne

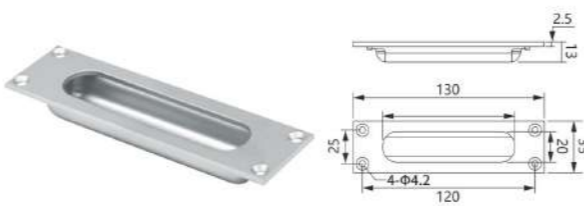

SDH-24
Material: Aluminum
Finish: Powder coating, Oil injection
Colour: Black, White, Silver



SDH-24-1
Material: Aluminum
Finish: Powder coating, Oil injection
Colour: Black, White, Silver



SDH-24-3A
Material: Stainless steel 201/304
Finish: Satin
Colour: Black, Silver



SDH-24-3B
Material: Stainless steel 201/304
Finish: Satin
Colour: Black, Silver



SDH-24-4
Material: Stainless steel 201/304
Finish: Satin
Colour: Black, Silver

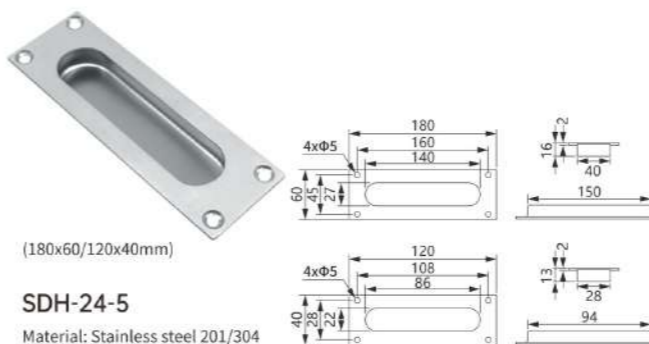

SDH-24-5
Material: Stainless steel 201/304
Finish: Satin
Colour: Black, Silver



SDH-24-6
Material: Stainless steel 201/304
Finish: Satin
Colour: Black, Silver

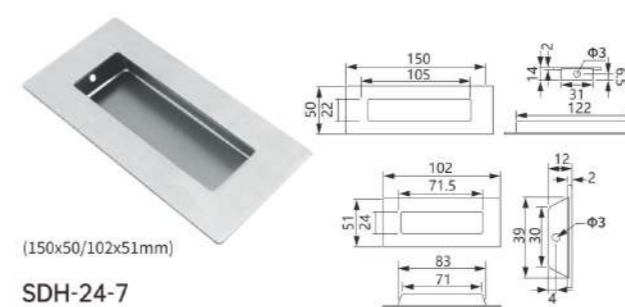

SDH-24-7
Material: Stainless steel 201/304
Finish: Satin
Colour: Black, Silver

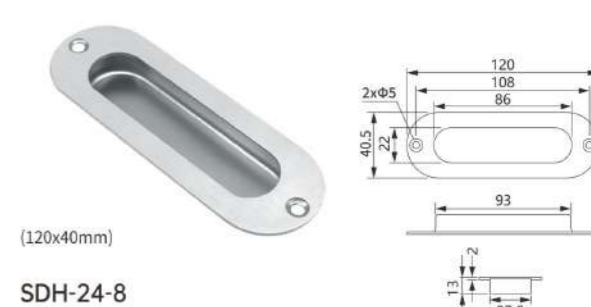

SDH-24-8
Material: Stainless steel 201/304
Finish: Satin
Colour: Black, Silver

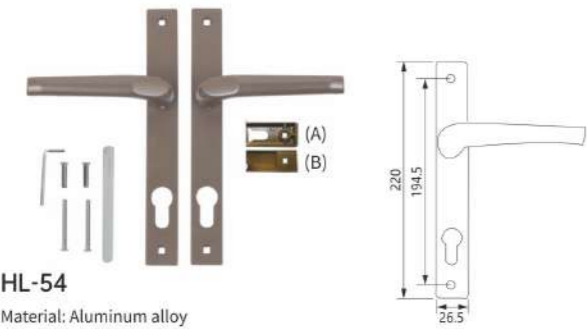

HL-54
Material: Aluminum alloy
Finish: Powder coating, Oil injection
Colour: Black, White, Silver, Brown, Beige, Champagne, Charcoal



HL-56
Material: Aluminum alloy
Finish: Powder coating, Oil injection
Colour: Black, White, Silver, Brown, Beige, Champagne



HL-54-1
Material: Stainless Steel 304
Finish: Satin



HL-56 (Dummy handle)
Material: Aluminum alloy
Finish: Powder coating, Oil injection
Colour: Black, White, Silver, Brown, Beige, Champagne



HL-55
Material: Aluminum alloy
Finish: Powder coating, Oil injection
Colour: Black, White, Silver, Brown, Beige, Champagne, Charcoal

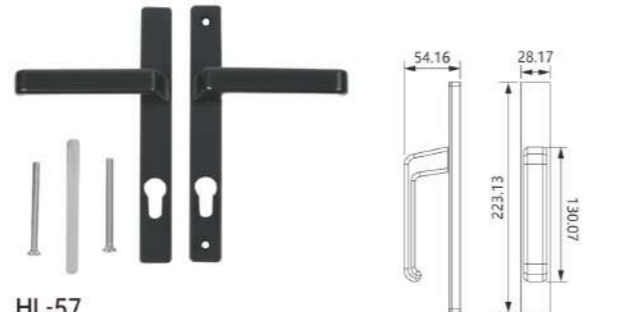

HL-57
Material: Aluminum alloy
Finish: Powder coating, Oil injection
Colour: Black, White, Silver, Brown, Beige, Champagne



HL-55-1
Material: Stainless Steel 304
Finish: Satin

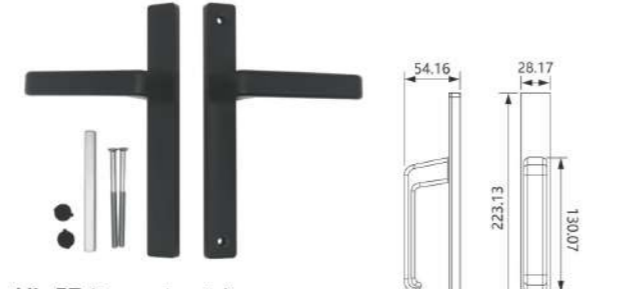

HL-57 (Dummy handle)
Material: Aluminum alloy
Finish: Powder coating, Oil injection
Colour: Black, White, Silver, Brown, Beige, Champagne



HL-57-1
Material: Iron plate + Aluminum alloy handle
Finish: Powder coating, Oil injection
Colour: Black, White, Silver, Brown, Beige, Champagne



HL-59
Material: Aluminum alloy
Finish: Powder coating, Oil injection
Colour: Black, White, Silver, Brown, Beige, Champagne



HL-58
Material: Aluminum alloy
Finish: Powder coating, Oil injection
Colour: Black, White, Silver, Brown, Beige, Champagne

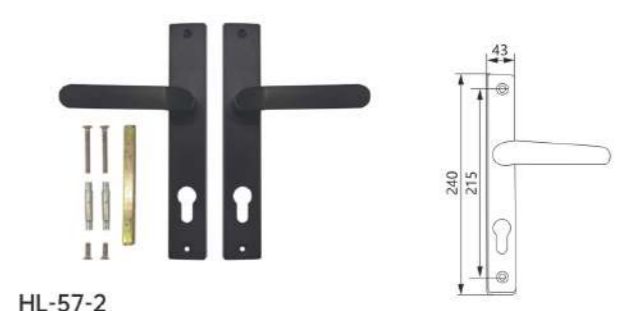

HL-57-2
Material: Iron plate + Aluminum alloy handle
Finish: Powder coating
Colour: Black, White, Silver, Brown, Beige, Champagne



CY-50
Material: Iron plate + Aluminum alloy handle
Finish: Powder coating



HL-61
Material: Aluminum
Finish: Powder coating, Oil injection
Colour: Black, White, Silver, Brown, Beige, Champagne

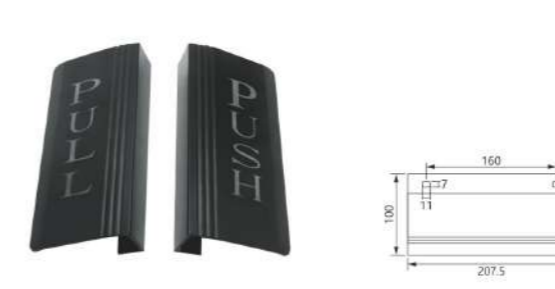

SDH-17
Material: Aluminum
Finish: Powder coating, Oil injection
Colour: Black, White, Silver

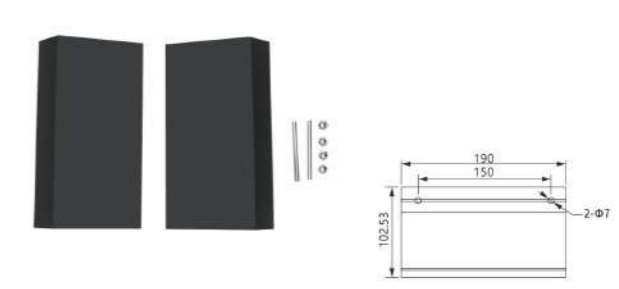

SDH-17-1
Material: Aluminum
Finish: Powder coating, Oil injection
Colour: Black, White, Silver, Brown, Beige, Champagne

Door Handle Hardware

- Security defender
- Easy to install
- Durable and economic
- Available in stainless steel material

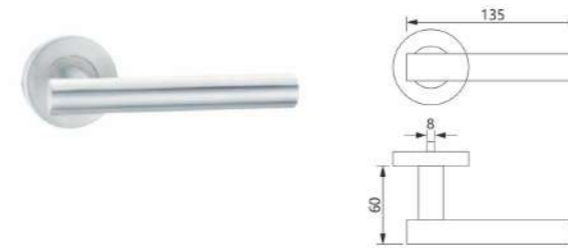

CY-08
Material: Stainless steel 201/304
Finish: Chrome

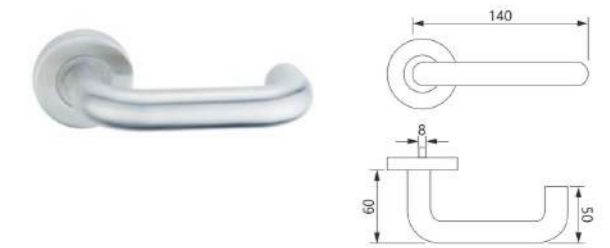

CY-21
Material: Stainless steel 201/304
Finish: Satin

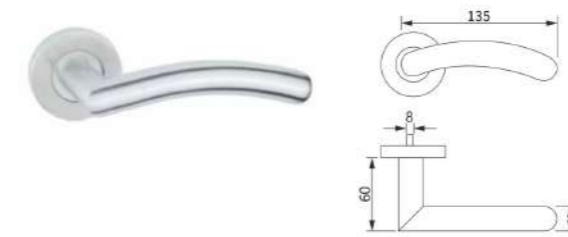

CY-08-1
Material: Stainless steel 201/304
Finish: Satin

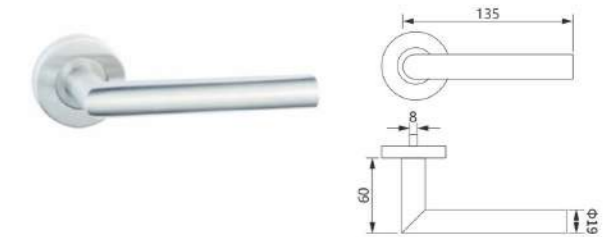

CY-22
Material: Stainless steel 201/304
Finish: Satin

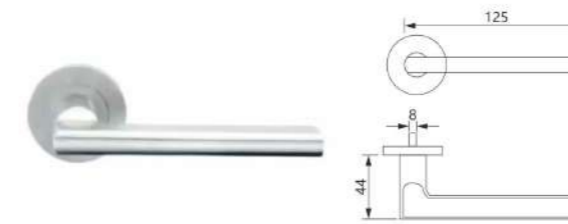

CY-09
Material: Stainless steel 201/304
Finish: Satin

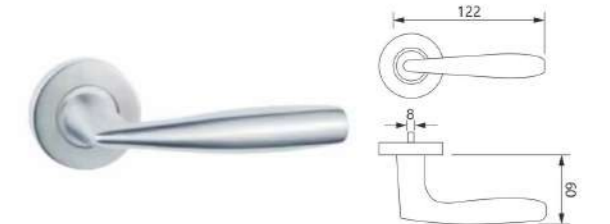

CY-38 (Solid handle)
Material: Stainless steel 201/304
Finish: Satin

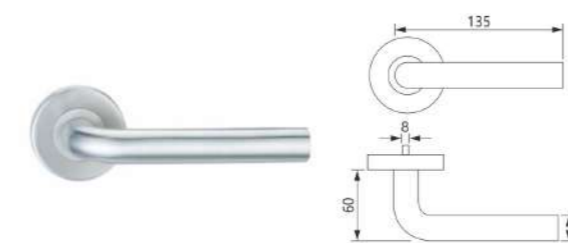

CY-20
Material: Stainless steel 201/304
Finish: Satin

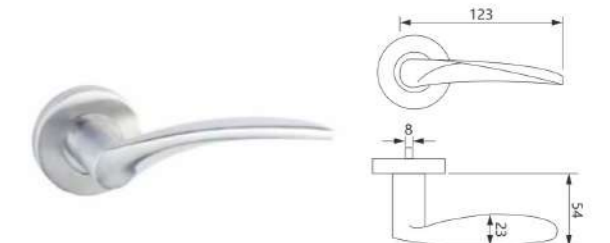

CY-39 (Solid handle)
Material: Stainless steel 201/304
Finish: Satin

LB-20x85mm LB-30x85mm
LB-25x85mm LB-35x85mm

Body Material: Iron
Panel Material: SS201/304
Zinc alloy oblique tongue + Square tongue

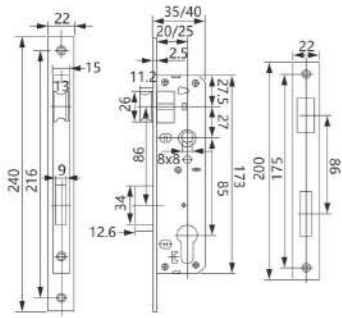

LBE-20x85mm LBE-30x85mm
LBE-25x85mm LBE-35x85mm

Body Material: Iron
Panel Material: SS201/304
Iron bump + Zinc alloy square tongue

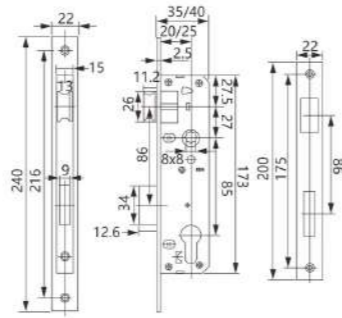

LBK-20x85mm LBK-30x85mm
LBK-25x85mm LBK-35x85mm

Body Material: All iron
Zinc alloy oblique tongue + Square tongue

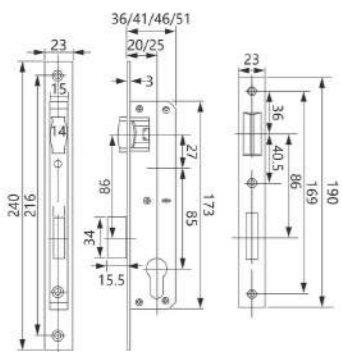

LBKR-20x85mm LBKR-30x85mm
LBKR-25x85mm LBKR-35x85mm

Body Material: All iron
Iron bump + Zinc alloy square tongue

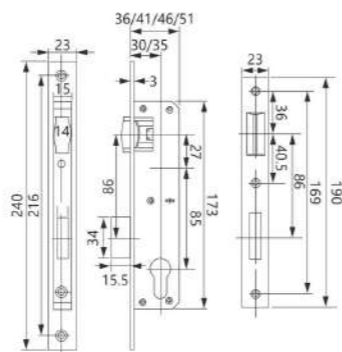

LBDH-5600

Body Material: Iron
Panel Material: SS304
Precision casting 304 hook tongue

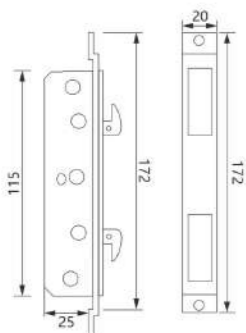

LB-5085-3

Body Material: Iron
Panel Material: SS201
Iron hook



LBL-25x85mm
LBL-35x85mm

Body Material: Iron
Panel Material: SS304
Iron material square tongue

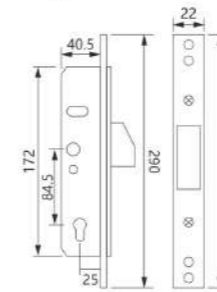

LBLH-25x85mm
LBLH-35x85mm

Body Material: Iron
Panel Material: SS304
Zinc alloy oblique tongue + Ironsquare tongue

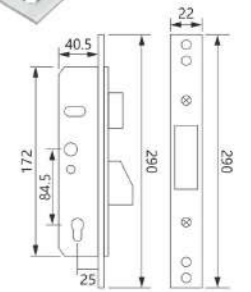

LBH-25x85mm
LBH-35x85mm

Body Material: Iron
Panel Material: SS304
Iron hook

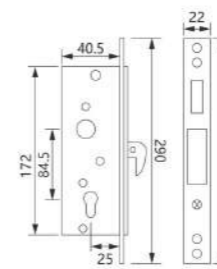

LBH-Z-25x85mm
LBH-Z-35x85mm

Body Material: Iron
Panel Material: SS304
Zinc alloy oblique tongue + Iron hook tongue

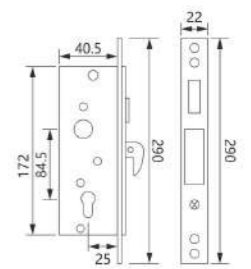

LBL-35-1

Body Material: Iron
Panel Material: SS201
Iron hook

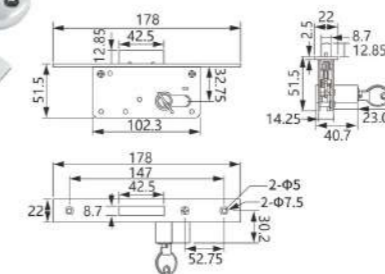

LBL-35-2

Body Material: Iron+SS201
Panel Material: SS201
Iron hook

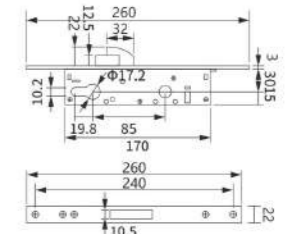

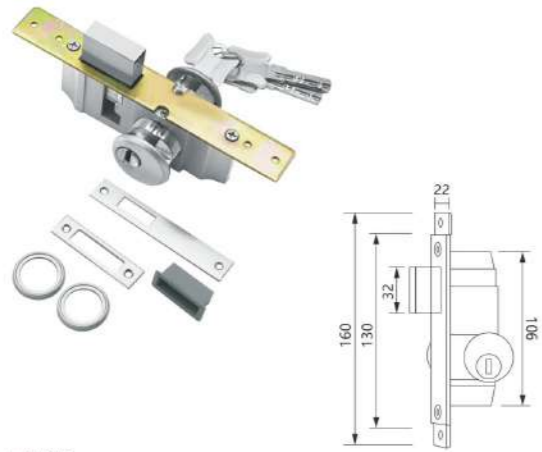

LB-15
Body Material: Aluminum alloy

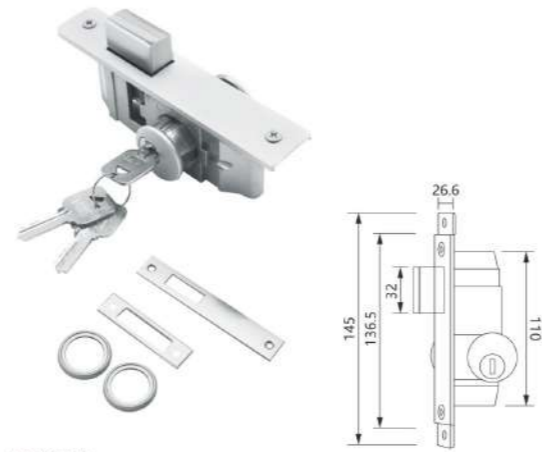

LB-15-1
Body Material: Aluminum alloy



LB-16
Material: Iron body + Copper lock



LB-18
Material: Iron body + Copper cylinder



LB-19
Material: Iron body + Copper lock

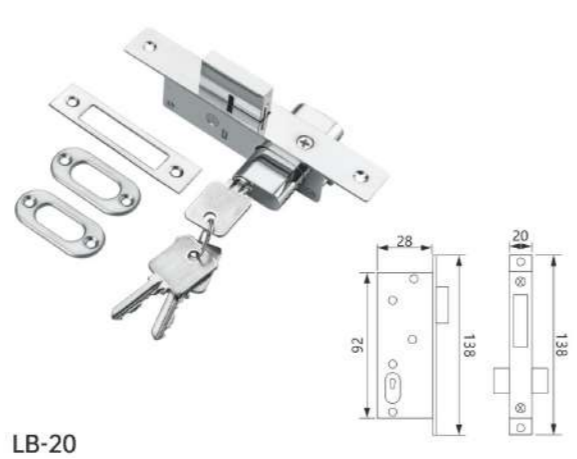

LB-20
Material: Iron body + Zinc alloy tongue + Copper cylinder

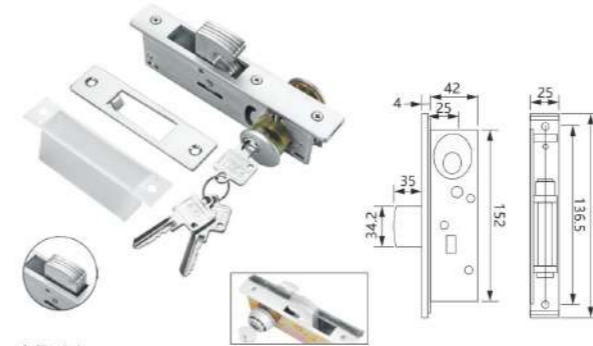

LB-14
Material: Iron body + Aluminum panel

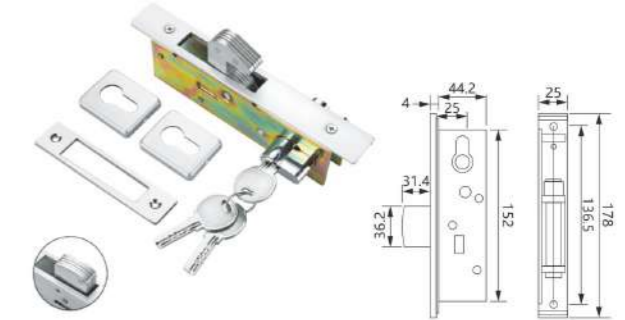

LB-14-1 (with normal cylinder)
Material: Iron body + Aluminum panel



Hook Lock
Body Material: Iron



SL-Anti lift
Body Material: Iron



SDH-21
Material: Plastic
Finish: Powder coating, Oil injection
Colour: Black, White, Silver



SDH-20
Material: Aluminum
Finish: Powder coating, Oil injection
Colour: Black, White, Silver

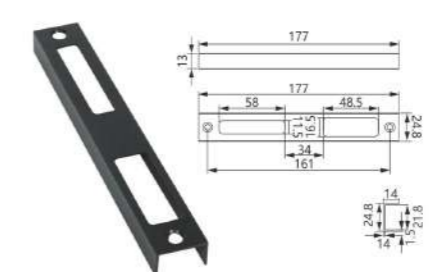

SDH-25
Material: Aluminum
Finish: Powder coating, Oil injection
Colour: Black, White, Silver

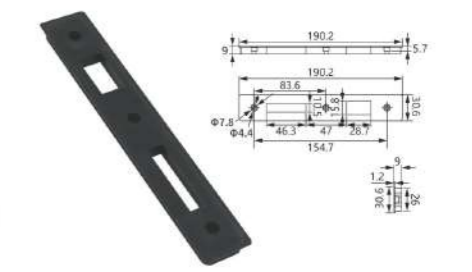

SDH-26
Material: Plastic
Colour: Black, White, Silver



Garage door lockset
Material: Iron + Zinc Alloy



MP-92 LB-21 LB-22

DIFFERENT FUNCTIONS OF LOCK CYLINDER

Finish: Satin nickel, Chrome, Matt black, Antique brass, Gold color,
Material available: all brass, all zinc alloy, zinc alloy shell and copper core



45mm all brass half cylinder (satin nickel)



60mm all brass (satin nickel) + normal key



60mm all brass (black) + normal key



75mm all brass (gold color) + computer key



Ball type

75mm all brass (satin nickel) + computer key, ball type

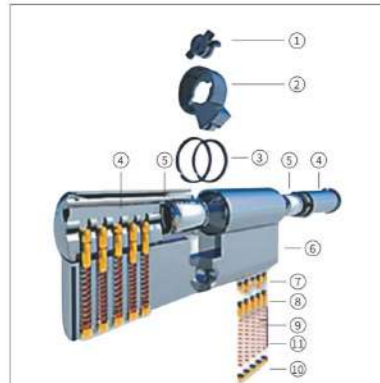

- 1. Clutch
- 2. Cam
- 3. Clip Rings
- 4. Barrel
- 5. Spacer (long cylinders only)
- 6. Housing
- 7. Key Pins
- 8. Middle Pins
- 9. Springs
- 10. Closing Pins
- 11. Anti-drill Pin

KEY SLOT



Item No.	A	B	C
CY-03	60mm	30.0	30.0
CY-03	70mm	35.0	35.0
CY-03	80mm	40.0	40.0
CY-03	80mm	40.0	40.0
CY-03	80mm	45.0	35.0
CY-03	90mm	45.0	45.0
CY-03	90mm	40.0	50.0
CY-03	100mm	50.0	50.0
CY-03	100mm	35.0	65.0
CY-03	110mm	55.0	55.0
CY-03	110mm	60.0	50.0
CY-03	120mm	60.0	60.0

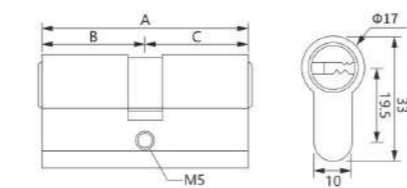

- 1. Material: Quality Solid Brass Body And Plug
- 2. Keys: 3 Brass Keys/5 Brass Keys
- 3. Key Type: Normal Key, Computer Key
- 4. Key Management Function: Master Key, Grand Master Key, Construction Key, Keyed Alike
- 5. Pins: 5 Brass Pins Standard, 10 Pin High Security With Two Line Pins, Other Sizes Available
- 6. Degree: 0 Degree, Or 30 Degree Offset Cam Inhibits Knock Through
- 7. Fastening screw: 65mm (standard), other lengths will be available according to different backset.

THE KEY MANAGEMENT FUNCTION

Keyed To Differ (KD)

Cylinders to differ are all operated by individual keys all different to each other.

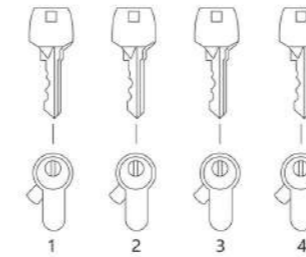

Keyed Alike Suites (KA)

All cylinders are operated by the same key. This gives an arrangement where one key will open a group of locks.

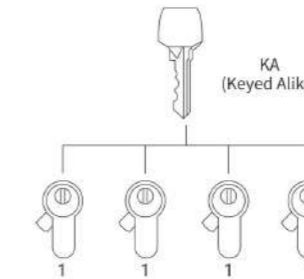

Common Entrance Suites

Each individual key is opened its own lock and the common entrance.

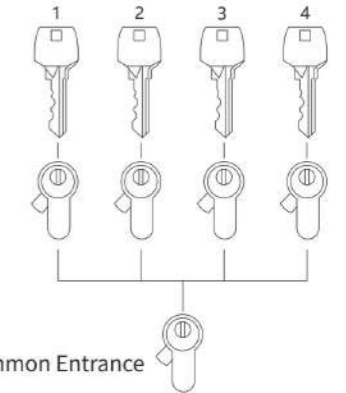

Master Key Suites (MK)

A group of cylinders, each equipped with an individual servant key, is also operated by one special key known as the master key. Keyed alike groups can also be incorporated into any master key suit.

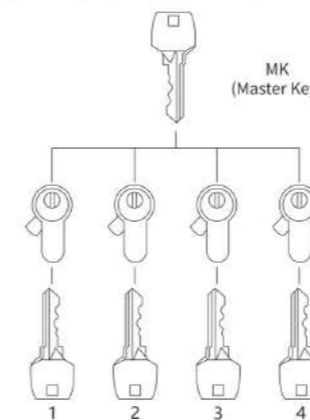

Construction Key (CK)

Construction key can operate the cylinder during construction period. After construction is ended up, Master Key can insert the cylinder and change the pin combination. The construction key can not open the same cylinder lock any more.

Building Construction

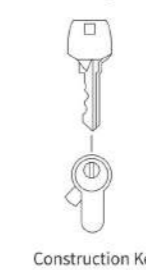

Construction Key

Building Completion

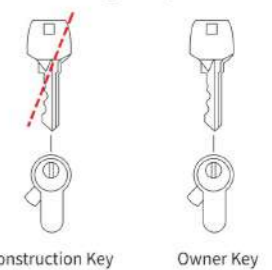

Construction Key

Owner Key

Grand Master Key Suites (GMK)

Master key groups are referred to as sub suites. In these instances all cylinders irrespective of their sub suite, are controlled by one key known as the grand master key.

Suitable for: Metal doors, Timber doors, Fire Rated doors etc. Can be used in Education, Healthcare, Hospitality, Government, and office facilities etc.

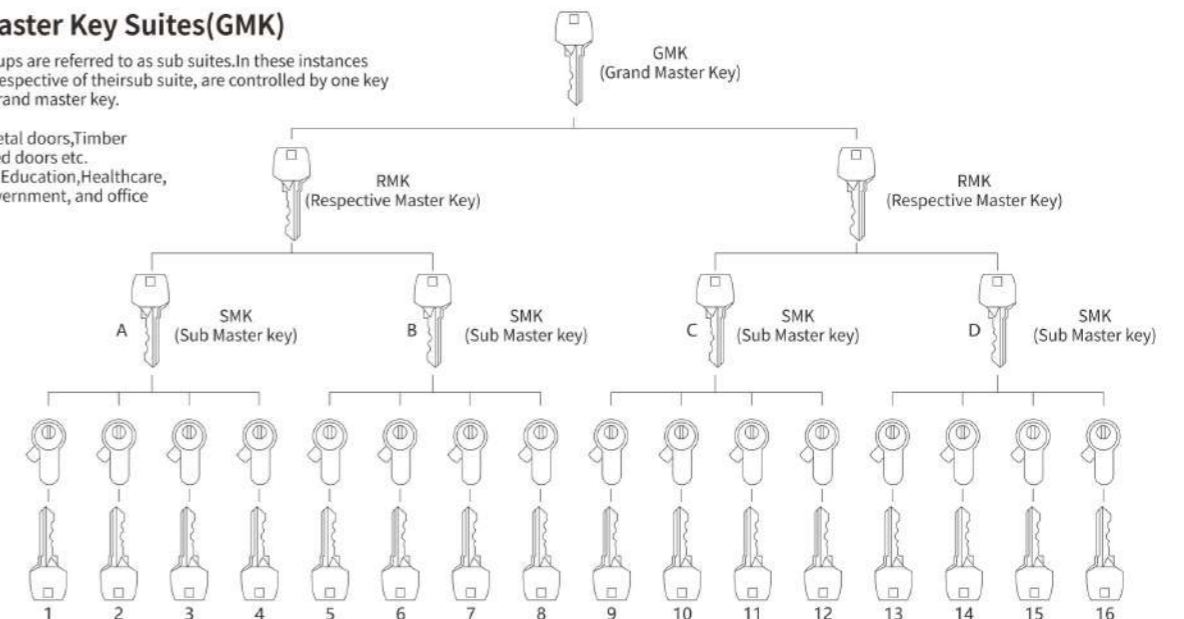

FB-1
Material: Zinc alloy
Finish: Powder coating, Oil injection
Colour: Black, White, Silver, Brown, Beige, Champagne

FB-4
Material: Zinc alloy
Finish: Powder coating, Oil injection
Colour: Black, White, Silver

FB-1-B
Material: Stainless steel 304
Finish: Satin

FB-4-1
Material: Zinc alloy
Finish: Powder coating, Oil injection
Colour: Black, White, Silver

FB-2
Material: Zinc alloy
Finish: Powder coating, Oil injection
Colour: Black, White, Silver

FB-24
Material: Aluminum alloy
Finish: Powder coating, Oil injection
Colour: Black, White, Silver

FB-3
Material: Zinc alloy
Finish: Powder coating, Oil injection
Colour: Black, White, Silver, Brown, Beige, Champagne

FB-16
Material: Aluminum
Finish: Powder coating, Oil injection
Colour: Black, White, Silver

FB-3-1
Material: Aluminum alloy + Zinc alloy
Finish: Powder coating, Oil injection
Colour: Black, White, Silver

FB-17
Material: Zinc alloy
Finish: Powder coating, Oil injection
Colour: Black, White, Silver

FB-5
Material: Aluminum
Finish: Powder coating, Oil injection
Colour: Black, White, Silver, Brown, Beige, Champagne

FB-7
Material: Zinc alloy
Finish: Powder coating, Oil injection
Colour: Black, White, Silver

FB-6
Material: Aluminum
Finish: Powder coating, Oil injection
Colour: Black, White, Silver

FB-7-1
Material: Zinc alloy
Finish: Powder coating, Oil injection
Colour: Black, White, Silver

FB-18
Material: Aluminum
Finish: Powder coating, Oil injection
Colour: Black, White, Silver, Brown, Beige, Champagne

FB-7-2
Material: Plastic
Finish: Powder coating, Oil injection
Colour: Black, White, Silver

FB-25
Material: Aluminum
Finish: Powder coating, Oil injection
Colour: Black, White, Silver

FB-8
Material: Zinc alloy
Finish: Powder coating, Oil injection
Colour: Black, White, Silver

FB-31
Material: Aluminum
Finish: Powder coating, Oil injection
Colour: Black, White, Silver

FB-8-1
Material: Zinc alloy/Aluminium alloy
Finish: Powder coating, Oil injection
Colour: Black, White, Silver

FB-9
Material: Aluminum alloy
Finish: Powder coating, Oil injection
Colour: Black, White, Silver

FB-10-2
Material: Aluminum
Finish: Powder coating, Oil injection
Colour: Black, White, Silver

FB-9-1
Material: Zinc alloy
Finish: Powder coating, Oil injection
Colour: Black, White, Silver

FB-11
Material: Stainless Steel 304
Size: 4"/5"/6"/8"/10"/12"

FB-9-2
Material: Stainless steel 304
Finish: Satin

FB-11-1
Material: Aluminum
Finish: Powder coating, Oil injection
Colour: Black, White, Silver

FB-10-A
Material: Aluminum
Finish: Powder coating, Oil injection
Colour: Black, White, Silver

FB-12
Material: Stainless Steel 304
Size: 4"/5"/6"/8"/10"/12"

FB-10-B
Material: Aluminum
Finish: Powder coating, Oil injection
Colour: Black, White, Silver

FB-13
Material: Stainless Steel 304
Size: 4"/5"/6"/8"/10"/12"

FB-14
Material: Stainless Steel 304
Size: 4"/5"/6"/8"/10"/12"

FB-26
Material: Aluminum
Finish: Powder coating, Oil injection
Colour: Black, White, Silver

FB-15
Material: Stainless Steel 304
Finish: 4"/5"/6"/8"/10"/12"

FB-27
Material: Aluminum
Finish: Powder coating, Oil injection
Colour: Black, White, Silver

FB-21
Material: Aluminum alloy + Iron
Finish: Powder coating, Oil injection
Colour: Black, White, Silver

FB-28
Material: Zinc alloy
Finish: Powder coating, Oil injection
Colour: Black, White, Silver



Aluminium Hardware Aluminium Hinge

- Security defender
- Easy to install
- Durable and economic
- Available in aluminium alloy material
- Professional to match with aluminium profile

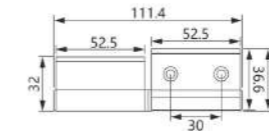

AH-01

Material: Aluminum
Finish: Powder coating, Oil injection, Oxidation
Colour: Black, White, Silver, Brown, Beige, Champagne

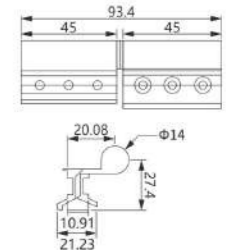

AH-05

Material: Aluminum(Zinc alloy Gasket)
Finish: Powder coating, Oil injection, Oxidation
Colour: Black, White, Silver, Brown, Beige, Champagne

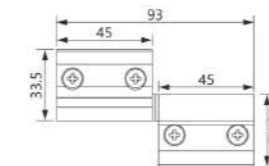

AH-02

Material: Aluminum
Finish: Powder coating, Oil injection, Oxidation
Colour: Black, White, Silver, Brown, Beige, Champagne



AH-06

Material: Aluminum
Finish: Powder coating, Oil injection, Oxidation
Colour: Black, White, Silver, Brown, Beige, Champagne

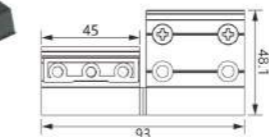

AH-03

Material: Aluminum
Finish: Powder coating, Oil injection, Oxidation
Colour: Black, White, Silver, Brown, Beige, Champagne



AH-07

Material: Aluminum
Finish: Powder coating, Oil injection
Colour: Black, White, Silver, Brown, Beige, Champagne

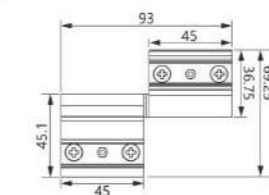

AH-04

Material: Aluminum
Size: 45mm/48mm
Finish: Powder coating, Oil injection, Oxidation
Colour: Black, White, Silver, Brown, Beige, Champagne

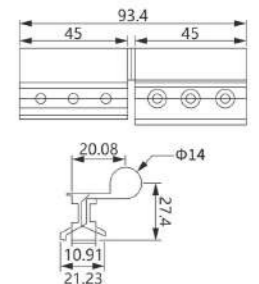

AH-08

Material: Aluminum alloy(SS201 Gasket)
Finish: Powder coating, Oil injection, Oxidation
Colour: Black, White, Silver, Brown, Beige, Champagne

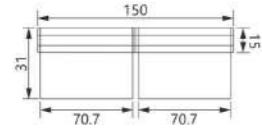

AH-09
Material: Aluminum
Finish: Powder coating, Oil injection, Oxidation
Colour: Black, White, Silver, Brown, Beige, Champagne

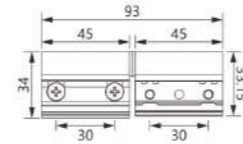

AH-13
Material: Aluminum
Finish: Powder coating, Oil injection, Oxidation
Colour: Black, White, Silver, Brown, Beige, Champagne

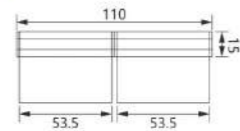

AH-10
Material: Aluminum
Finish: Powder coating, Oil injection, Oxidation
Colour: Black, White, Silver, Brown, Beige, Champagne

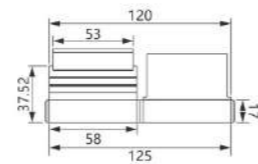

AH-14
Material: Aluminum
Finish: Powder coating, Oil injection, Oxidation
Colour: Black, White, Silver, Brown, Beige, Champagne

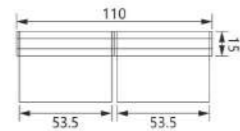

AH-11
Material: Aluminum
Finish: Powder coating, Oil injection, Oxidation
Colour: Black, White, Silver, Brown, Beige, Champagne

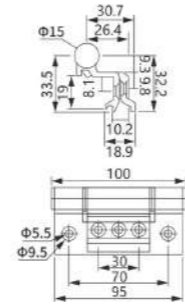

AH-15
Material: Aluminum
Finish: Powder coating, Oil injection, Oxidation
Colour: Black, White, Silver, Brown, Beige, Champagne

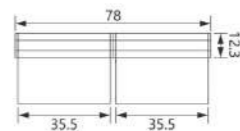

AH-12
Material: Aluminum
Finish: Powder coating, Oil injection, Oxidation
Colour: Black, White, Silver, Brown, Beige, Champagne

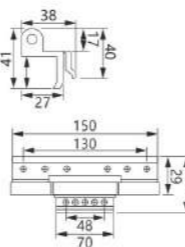

AH-16
Material: Aluminum
Finish: Powder coating, Oil injection, Oxidation
Colour: Black, White, Silver, Brown, Beige, Champagne

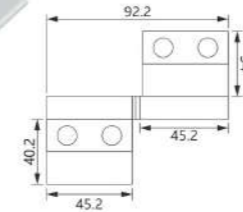

AH-17
Material: Aluminum
Finish: Powder coating, Oil injection, Oxidation
Colour: Black, White, Silver, Brown, Beige, Champagne

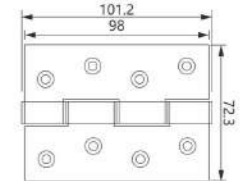

AH-21
Material: Aluminum
Finish: Powder coating, Oil injection, Oxidation
Colour: Black, White, Silver, Brown, Beige, Champagne

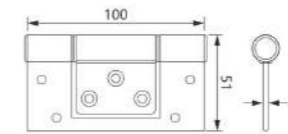

AH-18
Material: Aluminum
Finish: Powder coating, Oil injection, Oxidation
Colour: Black, White, Silver, Brown, Beige, Champagne

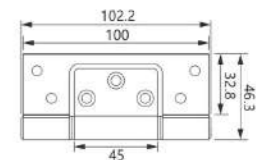

AH-22 (Iron pin)
Material: Aluminum
Finish: Powder coating, Oil injection, Oxidation
Colour: Black, White, Silver, Brown, Beige, Champagne, Charcoal

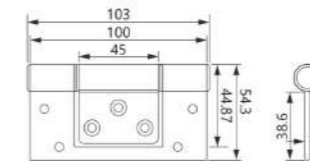

AH-19
Material: Aluminum
Finish: Powder coating, Oil injection, Oxidation
Colour: Black, White, Silver, Brown, Beige, Champagne, Charcoal

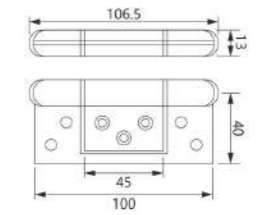

AH-23 (Aluminium pin)
Material: Aluminum
Finish: Powder coating, Oil injection, Oxidation
Colour: Black, White, Silver, Brown, Beige, Champagne, Charcoal

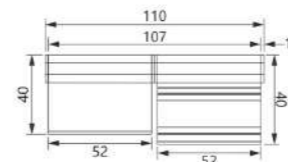

AH-20
Material: Aluminum
Finish: Powder coating, Oil injection, Oxidation
Colour: Black, White, Silver, Brown, Beige, Champagne

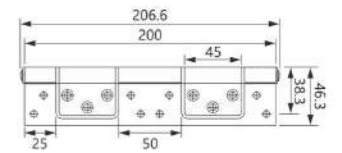

AH-24
Material: Aluminum
Finish: Powder coating, Oil injection, Oxidation
Colour: Black, White, Silver, Brown, Beige, Champagne, Charcoal

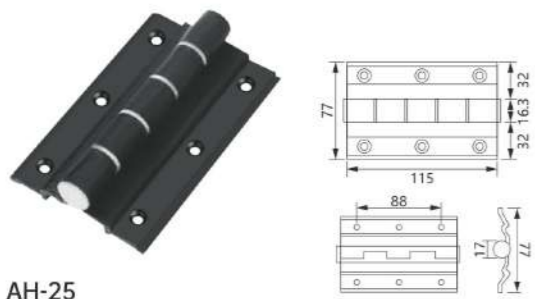

AH-25
Material: Aluminum
Finish: Powder coating, Oil injection, Oxidation
Colour: Black, White, Silver, Brown, Beige, Champagne

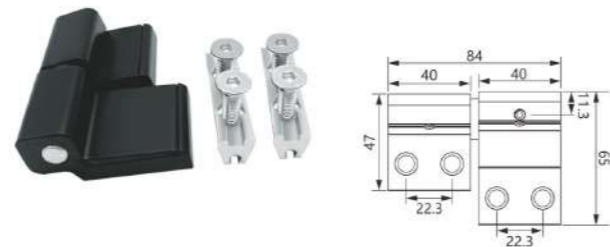

AH-27 (HL-6015)
Material: Aluminum
Finish: Powder coating, Oil injection, Oxidation
Colour: Black, White, Silver, Brown, Beige, Champagne

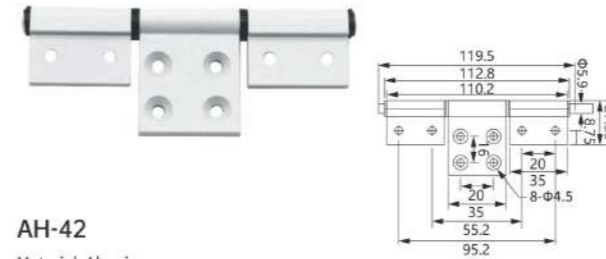

AH-42
Material: Aluminum
Finish: Powder coating, Oil injection, Oxidation
Colour: Black, White, Silver, Brown, Beige, Champagne



AH-43
Material: Zinc alloy
Finish: Powder coating, Oil injection, Oxidation
Colour: Black, White, Silver, Brown, Beige, Champagne

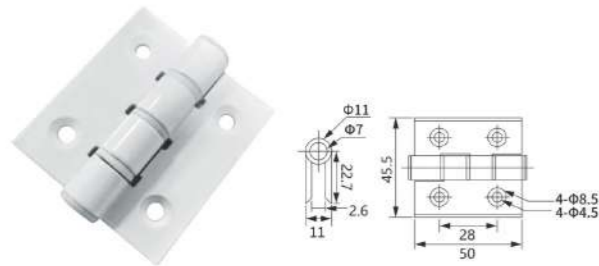

AH-39
Material: Aluminum
Finish: Powder coating, Oil injection, Oxidation
Colour: Black, White, Silver, Brown, Beige, Champagne



AH-27-1
Material: Aluminum
Finish: Powder coating, Oil injection, Oxidation
Colour: Black, White, Silver, Brown, Beige, Champagne

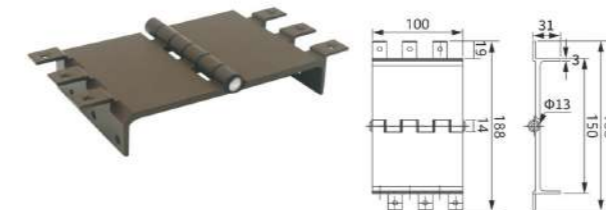

AH-45
Material: Aluminum
Finish: Powder coating, Oil injection, Oxidation
Colour: Black, White, Silver, Brown, Beige, Champagne, Charcoal



AH-43B
Material: Zinc alloy
Finish: Powder coating, Oil injection, Oxidation
Colour: Black, White, Silver, Brown, Beige, Champagne

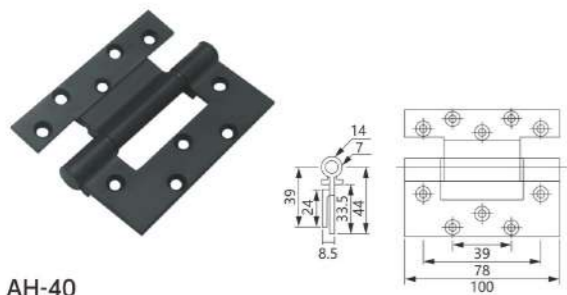

AH-40
Material: Aluminum
Finish: Powder coating, Oil injection, Oxidation
Colour: Black, White, Silver, Brown, Beige, Champagne



AH-28 (HL-6011)
Material: Aluminum
Finish: Powder coating, Oil injection, Oxidation
Colour: Black, White, Silver, Brown, Beige, Champagne

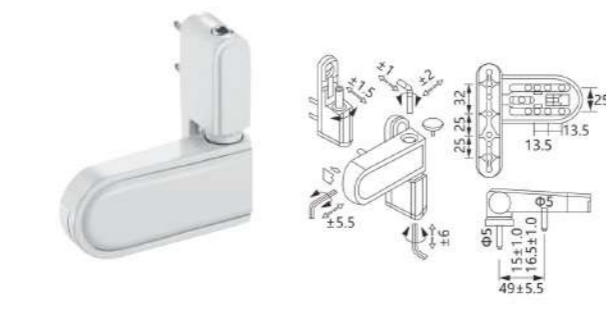

AH-26
Material: Aluminum alloy
Finish: Powder coating



Pivot hinge-1
Material: Aluminum alloy
Finish: Powder coating, Oil injection, Oxidation
Colour: Black, White, Silver, Grey, Beige



AH-49
Material: Aluminum
Finish: Powder coating, Oil injection, Oxidation
Colour: Black, White, Silver, Brown, Beige, Champagne



AH-29
Material: Aluminum
Finish: Powder coating, Oil injection, Oxidation
Colour: Black, White, Silver, Brown, Beige, Champagne



Pivot hinge-2
Material: Aluminum alloy
Finish: Powder coating, Oil injection, Oxidation
Colour: Black, White, Silver, Grey, Beige



Pivot hinge-3
Material: Aluminum alloy
Finish: Powder coating, Oil injection, Oxidation
Colour: Black, White, Silver, Brown, Beige, Champagne

Aluminium Doors

- 100mm or 115mm hinge are available
- All components are stainless steel
- Improved design on top guide
- Recommended maximum leaf height -3000mm
- Recommended maximum leaf width -900mm
- Recommended 3 or maximum 5 doors hinged, together and to the frame, folding either way and max.leaf 60kg



BUTT STYLE



Intermediate hinge

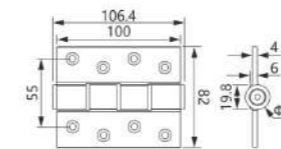

AH-31

Material: Aluminum
Finish: Powder coating, Oil injection, Oxidation
Colour: Black, White, Silver, Brown, Beige, Champagne, Charcoal



Top guide

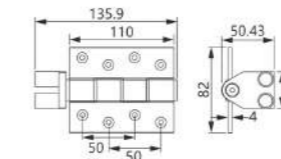

AH-32

Material: Aluminum
Finish: Powder coating, Oil injection, Oxidation
Colour: Black, White, Silver, Brown, Beige, Champagne, Charcoal



Hinge handle

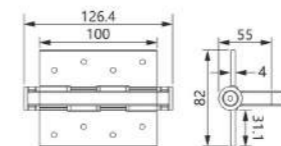

AH-33

Material: Aluminum
Finish: Powder coating, Oil injection, Oxidation
Colour: Black, White, Silver, Brown, Beige, Champagne, Charcoal



Bottom roller

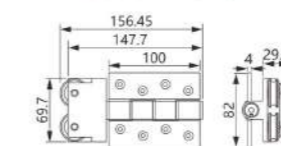

AH-34

Material: Aluminum
Finish: Powder coating, Oil injection, Oxidation
Colour: Black, White, Silver, Brown, Beige, Champagne, Charcoal

SINKLESS STYLE



Intermediate hinge

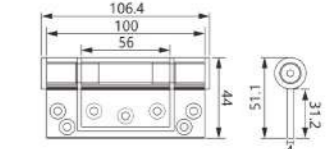

AH-35

Material: Aluminum
Finish: Powder coating, Oil injection, Oxidation
Colour: Black, White, Silver, Brown, Beige, Champagne, Charcoal



Top guide

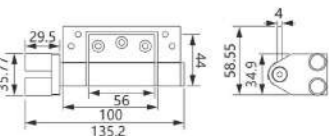

AH-36

Material: Aluminum
Finish: Powder coating, Oil injection, Oxidation
Colour: Black, White, Silver, Brown, Beige, Champagne, Charcoal



Hinge handle

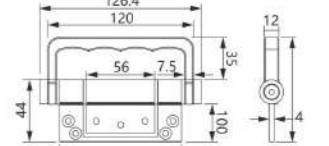

AH-37

Material: Aluminum
Finish: Powder coating, Oil injection, Oxidation
Colour: Black, White, Silver, Brown, Beige, Champagne, Charcoal



Bottom roller

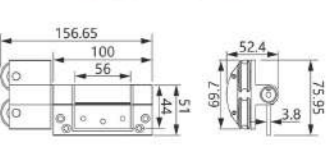

AH-38

Material: Aluminum
Finish: Powder coating, Oil injection, Oxidation
Colour: Black, White, Silver, Brown, Beige, Champagne, Charcoal

Sliding Door Lock

- Security defender
- Easy to install
- Durable and economic
- Available in aluminium alloy material

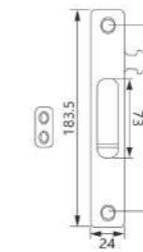

WL-01
Material: Aluminum
Finish: Powder coating, Oil injection
Colour: Black, White, Silver, Beige



WL-04 (WL-33-1)
Material: Zinc alloy
Finish: Powder coating, Oil injection, Oxidation
Colour: Black, White, Silver, Beige

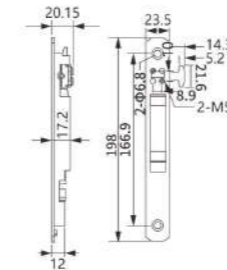

WL-02 (with key/without key)
Material: Zinc alloy/Aluminum alloy
Fitting Material: Zinc alloy/SS201
Finish: Powder coating, Oil injection
Colour: Black, White, Silver, Beige



WL-04-1 (WL-33-2)
Material: Zinc alloy
Finish: Powder coating, Oil injection, Oxidation
Colour: Black, White, Silver, Brown, Beige, Champagne, Charcoal



WL-02-1
Material: Zinc alloy/Aluminum alloy
Finish: Powder coating, Oil injection
Colour: Black, White, Silver, Beige

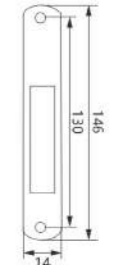

WL-06
Material: Aluminum alloy
Finish: Powder coating, Oil injection
Colour: Black, White, Silver, Beige

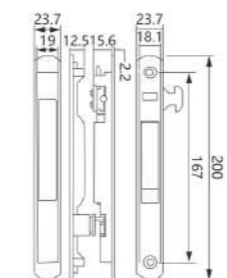

WL-03
Material: Zinc alloy/Aluminum alloy
Fitting Material: Zinc alloy/SS201
Finish: Powder coating, Oil injection
Colour: Black, White, Silver, Beige

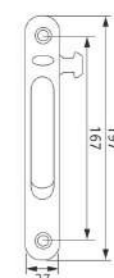

WL-07
Material: Aluminum alloy
Finish: Powder coating, Oil injection
Colour: Black, White, Silver, Beige

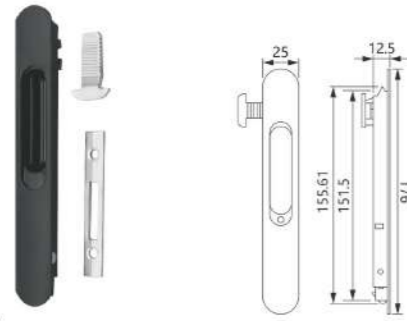

WL-08
Material: Aluminum
Finish: Powder coating, Oil injection
Colour: Black, White, Silver, Beige

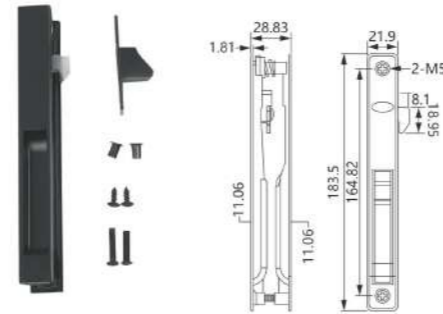

WL-12
Material: Aluminum alloy
Finish: Powder coating, Oil injection
Colour: Black, White, Silver, Beige

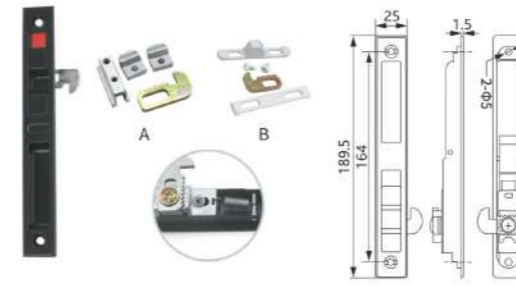

WL-21 (with spring/without spring)
Material: Aluminum alloy
Finish: Powder coating, Oil injection
Colour: Black, White, Silver, Beige

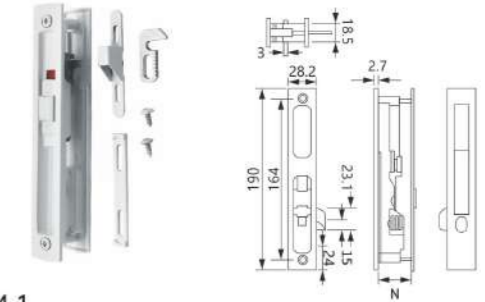

WL-24-1
Material: Aluminum alloy
Finish: Powder coating, Oil injection
Colour: Black, White, Silver, Beige

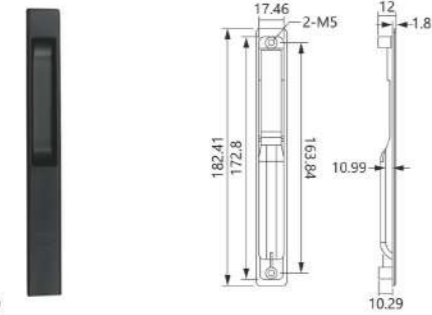

WL-09
Material: Aluminum alloy
Finish: Powder coating, Oil injection
Colour: Black, White, Silver, Beige

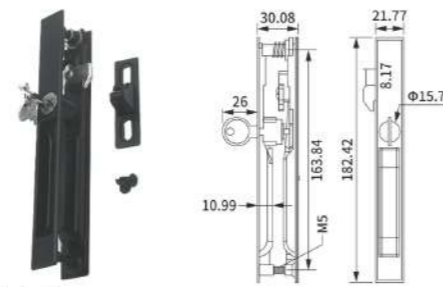

WL-13 (with key)
Material: Aluminum alloy
Finish: Powder coating, Oil injection
Colour: Black, White, Silver, Beige

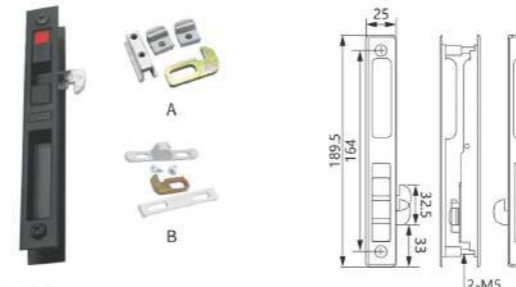

WL-22
Material: Aluminum alloy
Finish: Powder coating, Oil injection
Colour: Black, White, Silver, Beige

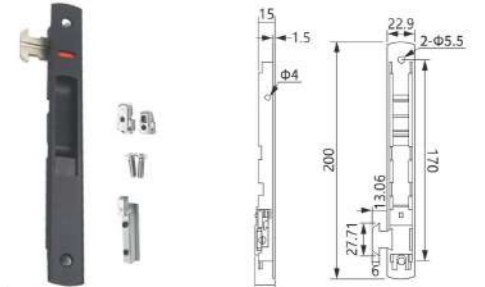

WL-27
Material: Aluminum
Finish: Powder coating, Oil injection
Colour: Black, White, Silver, Beige

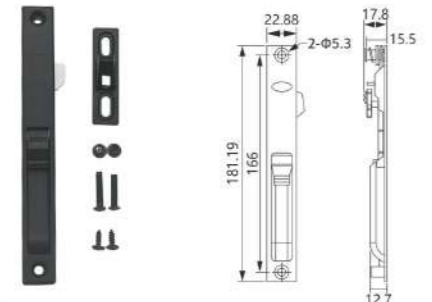

WL-10
Material: Aluminum alloy/Aluminum alloy + Plastic
Finish: Powder coating, Oil injection
Colour: Black, White, Silver, Beige

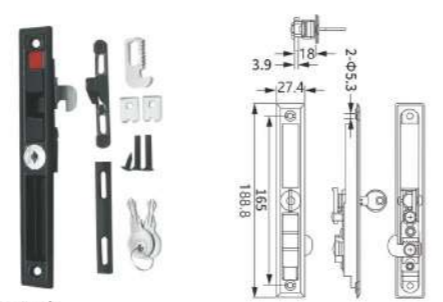

WL-19 (with key)
Material: Zinc alloy
Finish: Powder coating, Oil injection
Colour: Black, White, Silver, Beige

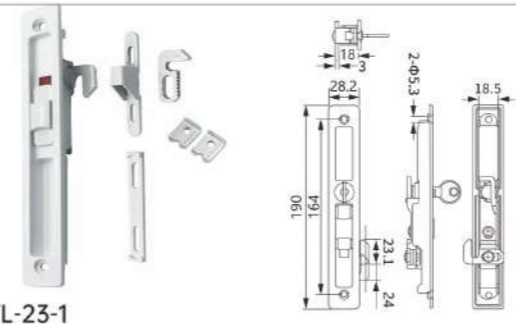

WL-23-1
Material: Aluminum alloy
Finish: Powder coating, Oil injection
Colour: Black, White, Silver, Beige

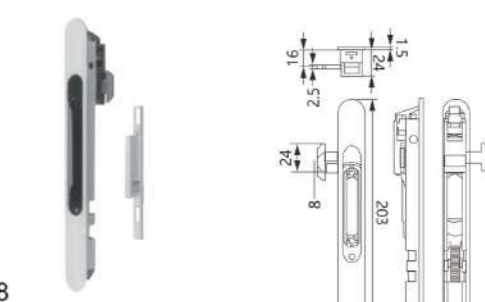

WL-28
Material: Aluminum
Finish: Powder coating, Oil injection
Colour: Black, White, Silver, Beige



WL-10B
Material: Zinc alloy
Finish: Powder coating, Oil injection
Colour: Black, White, Silver, Beige

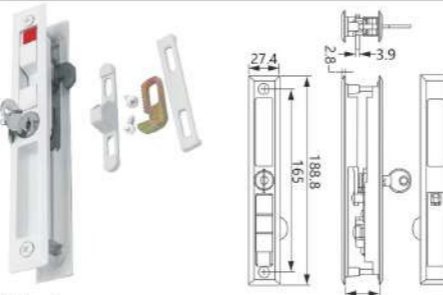

WL-20 (with key)
Material: Zinc alloy
Finish: Powder coating, Oil injection
Colour: Black, White, Silver, Beige



WL-24
Material: Aluminum alloy
Finish: Powder coating, Oil injection
Colour: Black, White, Silver, Beige

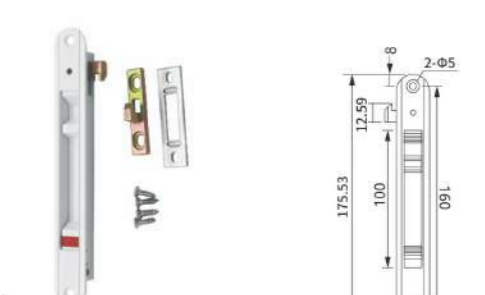

WL-29
Material: Aluminum
Finish: Powder coating, Oil injection
Colour: Black, White, Silver, Beige



WL-29-2
Material: Aluminum
Finish: Powder coating, Oil injection
Colour: Black, White, Silver, Beige



WL-38
Material: Aluminum alloy
Finish: Powder coating, Oil injection
Colour: Black, White, Silver, Beige



WL-30A(30B)
Material: Aluminum
Finish: Powder coating, Oil injection
Colour: Black, White, Silver, Beige



WL-39 (with key)
Material: Aluminum alloy
Finish: Powder coating, Oil injection
Colour: Black, White, Silver, Beige

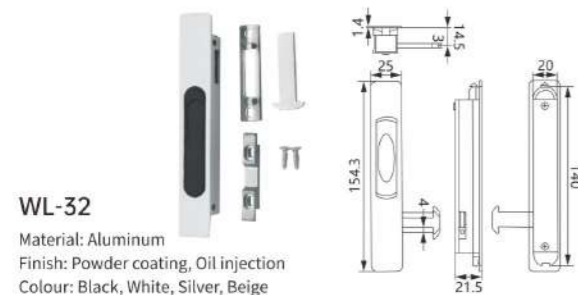

WL-32
Material: Aluminum
Finish: Powder coating, Oil injection
Colour: Black, White, Silver, Beige

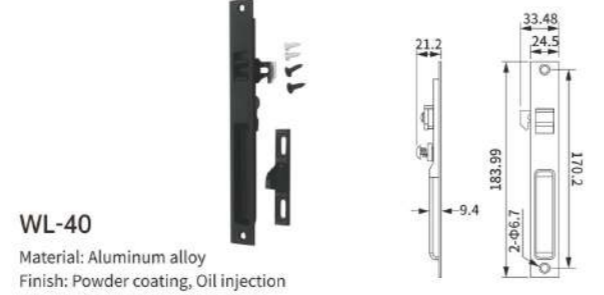

WL-40
Material: Aluminum alloy
Finish: Powder coating, Oil injection
Colour: Black, White, Silver, Beige

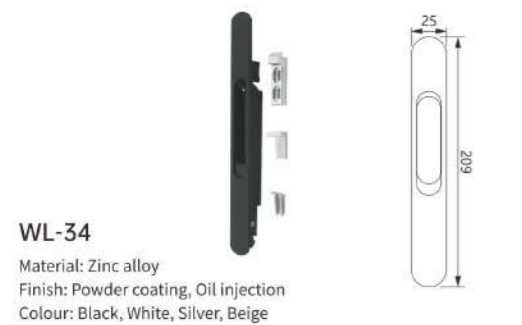

WL-34
Material: Zinc alloy
Finish: Powder coating, Oil injection
Colour: Black, White, Silver, Beige



WL-42
Material: Aluminum
Finish: Powder coating, Oil injection
Colour: Black, White, Silver, Beige



WL-37
Material: Aluminum alloy
Finish: Powder coating, Oil injection
Colour: Black, White, Silver, Beige



WL-43 (7D)
Material: Aluminum alloy
Finish: Powder coating, Oil injection
Colour: Black, White, Silver, Beige



WL-44 (8D)
Material: Aluminum alloy
Finish: Powder coating, Oil injection
Colour: Black, White, Silver, Beige



WL-49
Material: Aluminum
Finish: Powder coating, Oil injection
Colour: Black, White, Silver, Beige



WL-54
Material: Aluminum
Finish: Powder coating, Oil injection
Colour: Black, White, Silver, Beige



WL-47
Material: Aluminum
Finish: Powder coating, Oil injection, Anodized
Colour: Black, Silver, Champagne, Titano, Mate



WL-50
Material: Aluminum
Finish: Powder coating, Oil injection
Colour: Black, White, Silver, Beige



WL-55
Material: Aluminum
Finish: Powder coating, Oil injection
Colour: Black, White, Silver, Beige



WL-47-1
Material: Aluminum
Finish: Powder coating, Oil injection, Anodized
Colour: Black, Silver, Champagne, Titano, Mate



WL-51
Material: Aluminum
Finish: Powder coating, Oil injection
Colour: Black, White, Silver, Beige



WL-56
Material: Aluminum
Finish: Powder coating, Oil injection
Colour: Black, White, Silver, Beige



WL-48
Material: Aluminum
Finish: Powder coating, Oil injection, Anodized
Colour: Black, Silver, Champagne, Titano, Mate



WL-52
Material: Aluminum
Finish: Powder coating, Oil injection
Colour: Black, White, Silver, Beige



WL-57
Material: Aluminum
Finish: Powder coating, Oil injection
Colour: Black, White, Silver, Beige



WL-48-1
Material: Aluminum
Finish: Powder coating, Oil injection, Anodized
Colour: Black, Silver, Champagne, Titano, Mate



WL-53
Material: Aluminum
Finish: Powder coating, Oil injection
Colour: Black, White, Silver, Beige



WL-58
Material: Aluminum
Finish: Powder coating, Oil injection
Colour: Black, White, Silver, Beige

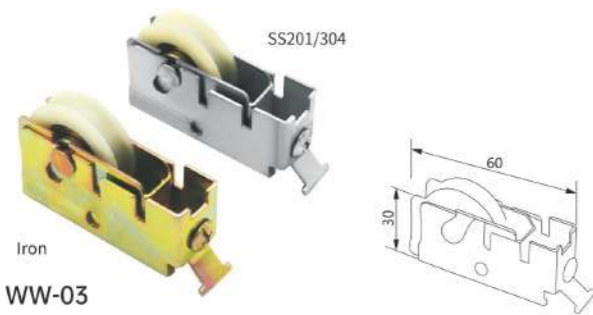

WW-03

Material: Stainless steel/Iron
Finish: Iron plated color galvanized
Wheel Size: Φ 32mm

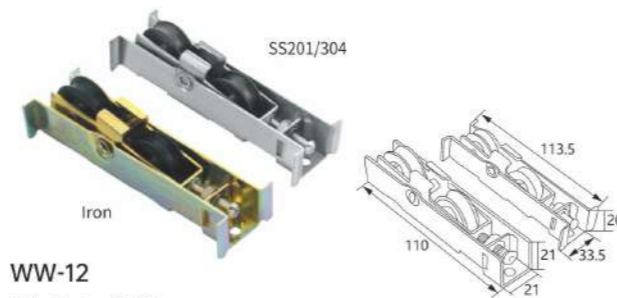

WW-12

Material: Iron/SS304
Finish: Iron plated color galvanized
Wheel Size: Φ 26mm

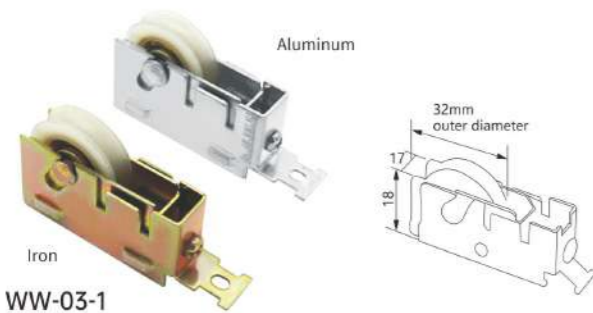

WW-03-1

Material: Aluminum/Iron
Finish: Iron plated color galvanized
Wheel Size: Φ 32mm

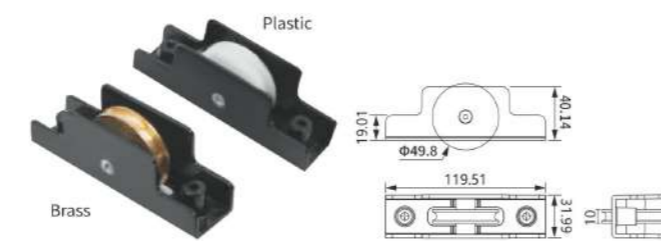

WW-34

Material: Aluminum alloy
Finish: Powder coating
Wheel Size: Φ 50mm



WW-13

Material: Iron/SS304
Finish: Iron plated color galvanized
Wheel Size: Φ 32mm

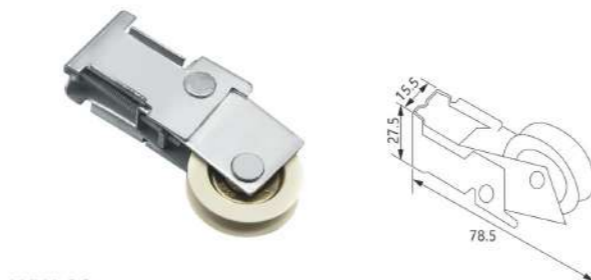

WW-22

Material: Iron
Finish: White zinc plated
Wheel Size: Φ 31.5mm



WW-11

Material: Iron/SS304
Finish: Iron plated color galvanized
Wheel Size: Φ 26.5mm

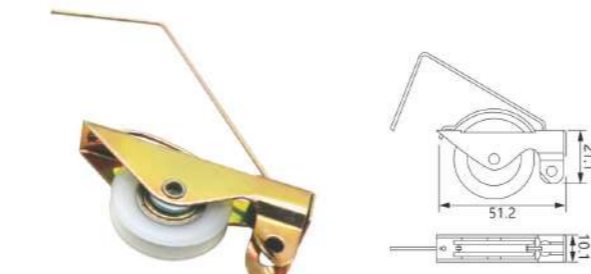

WW-36

Material: Iron
Wheel Size: Φ 25.5mm



WW-04 (with bearing/without bearing)

Material: Iron
Finish: Iron plated color galvanized
Wheel Size: Φ 37mm

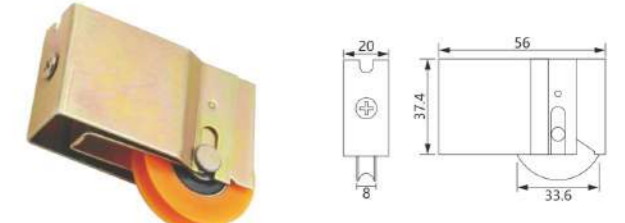

WW-72

Material: Iron
Finish: Color zinc plating
Wheel Size: Φ 33.6mm

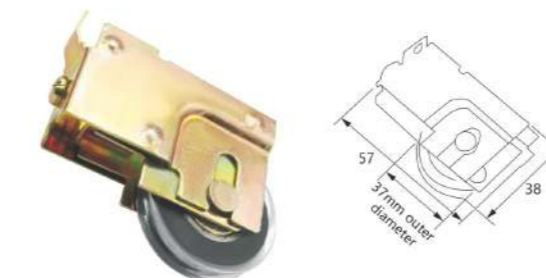

WW-04-1

Material: Iron
Finish: Iron plated color galvanized
Wheel Size: Φ 38mm

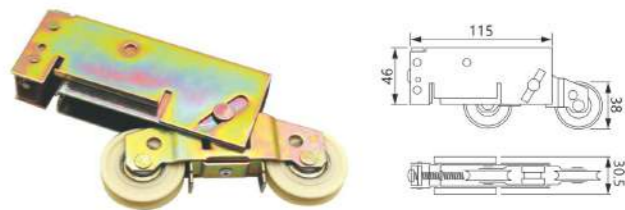

WW-75

Material: Iron + Nylon
Finish: Color zinc plating
Wheel Size: Φ 38mm

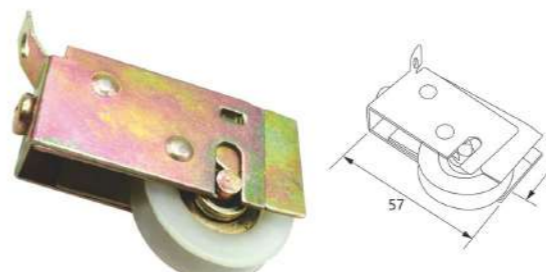

WW-28

Material: Iron
Finish: Color zinc plating
Wheel Size: Φ 32mm



WW-75-1

Material: Iron
Finish: Color zinc plating
Wheel Size: Φ 38mm



WW-28-1

Material: Iron
Finish: Color zinc plating
Wheel Size: Φ 32mm

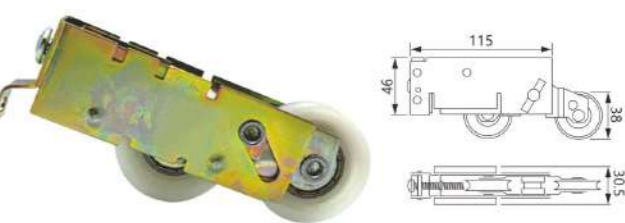

WW-75-2

Material: Iron
Finish: Color zinc plating
Wheel Size: Φ 38mm

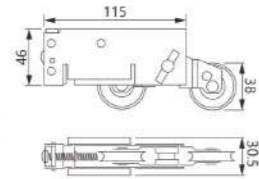

WW-75-3

Material: Iron
Finish: Color zinc plating
Wheel Size: Φ 38mm

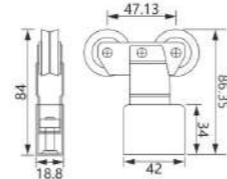

WW-26-D(L26)

Material: Iron
Finish: Iron plated color galvanized
Wheel Size: Φ 32mm

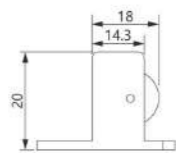

WW-41

Material: Plastic
Wheel Size: Φ 29mm

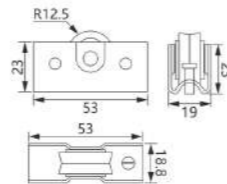

WW-84

Material: Iron
Finish: Color zinc plating
Wheel Size: Φ 24mm

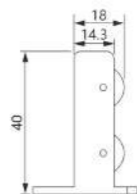

WW-41-D

Material: Plastic
Wheel Size: Φ 19.5mm

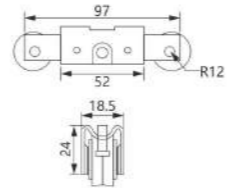

WW-85

Material: Iron
Finish: Color zinc plating
Wheel Size: Φ 24mm

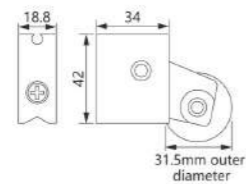

WW-26 (L25)

Material: Iron
Finish: Iron plated color galvanized
Wheel Size: Φ 31.5mm

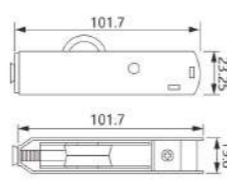

WW-78

Material: Iron
Finish: Color zinc plating
Wheel Size: Φ 25mm

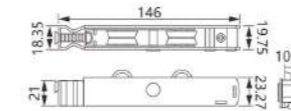

WW-79

Material: Iron
Finish: Color zinc plating
Wheel Size: Φ 25mm

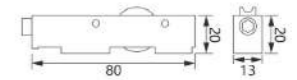

WW-73

Material: SS201

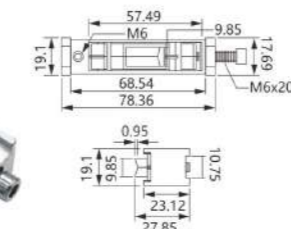

WW-102

Material: Zinc alloy
Finish: White zinc plated
Wheel Size: Φ 21mm

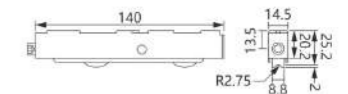

WW-73-D

Material: SS201

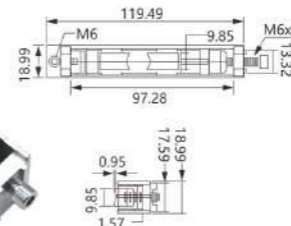

WW-103

Material: Zinc alloy
Finish: White zinc plated
Wheel Size: Φ 21mm

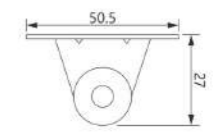
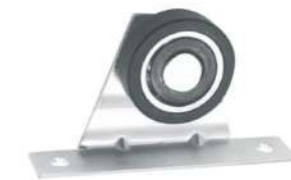

WW-43-1

Material: Iron
Finish: Blue zinc plated
Wheel Size: Φ 20mm

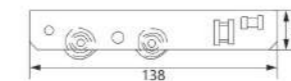

WW-25

Material: Iron
Finish: Iron plated color galvanized
Wheel Size: Φ 19mm

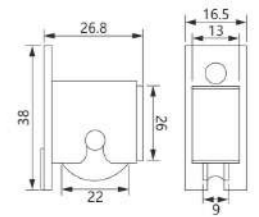

WW-31 (L20)

Material: Plastic
Wheel Size: Φ 22mm

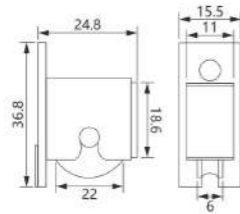

WW-31-1 (L5000)
Material: Plastic
Wheel Size: Φ 22mm

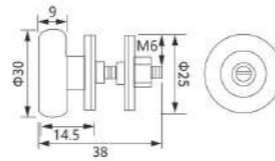

WW-14
Material: Iron
Finish: Iron plated color galvanized
Wheel Size: Φ 30mm

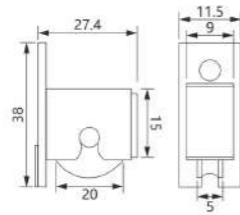

WW-31-2
Material: Plastic
Wheel Size: Φ 20mm

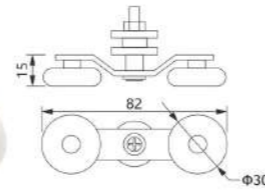

WW-14-D
Material: Iron
Finish: Iron plated color galvanized
Wheel Size: Φ 30mm



WW-96 (L5000)
Material: Nylon
Wheel Size: Φ 20.1mm

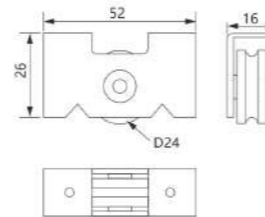

WW-42-1
Material: Iron
Finish: Electrophoresis
Wheel Size: Φ 26mm



WW-97 (L20)
Material: Nylon
Wheel Size: Φ 22mm

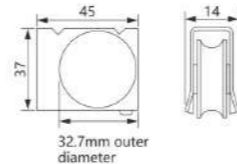

WW-51
Material: Aluminium, Iron
Finish: Electrophoresis
Wheel Size: Φ 26mm

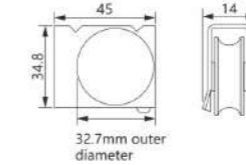

WW-42-2
Material: Iron
Finish: Electrophoresis
Wheel Size: Φ 26mm

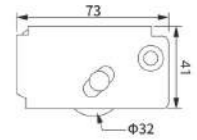

WW-45
Material: Iron
Finish: Electrophoresis
Wheel Size: Φ 32mm

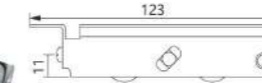

WW-39
Material: Iron
Finish: White zinc plated
Wheel Size: Φ 20.3mm

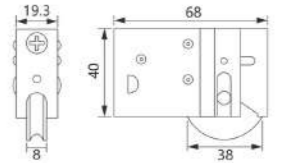
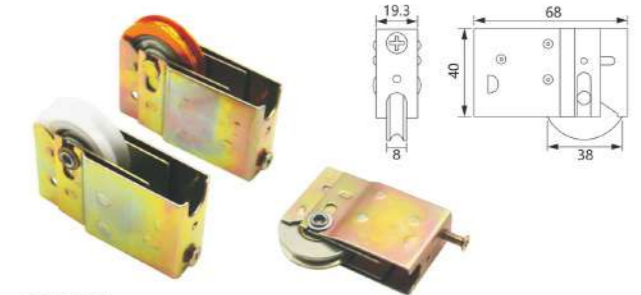

WW-57
Material: Iron
Finish: Iron plated color galvanized
Wheel Size: Φ 30mm

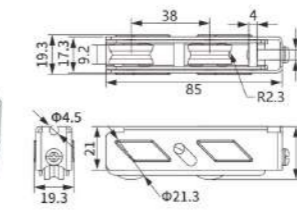

WW-94
Material: Iron
Finish: Iron plated color galvanized
Wheel Size: Φ 32/41mm

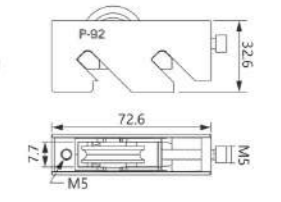

WW-15 (P-92)
Material: Zinc alloy
Finish: Electroplating blue zinc
Wheel Size: Φ 28mm
Bearing: 30kg

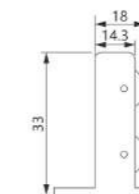

WW-41-1
Material: Plastic
Wheel Size: Φ 13mm

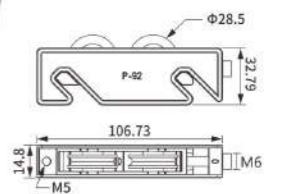

WW-15-D (P-92)
Material: Zinc alloy
Finish: Electroplating blue zinc
Wheel Size: Φ 28mm
Bearing: 60kg



WW-15-1 (P-65)

Material: Zinc alloy
Finish: Electroplating blue zinc
Wheel Size: $\Phi 22$ mm
Bearing: 25kg

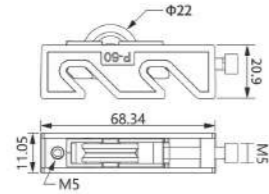

WW-80

Material: Iron
Finish: Color zinc plating
Wheel Size: $\Phi 32/38$ mm

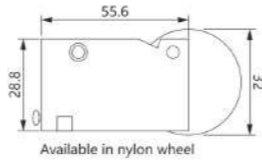

WW-15-1-D (P-65)

Material: Zinc alloy
Finish: Electroplating blue zinc
Wheel Size: $\Phi 22$ mm
Bearing: 50kg

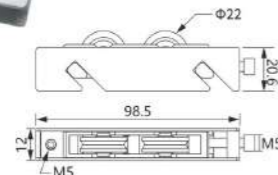

WW-09-3

Material: Iron
Finish: Iron plated color galvanized
Wheel Size: $\Phi 38$ mm

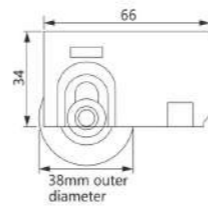

WW-15-E (M-100)

Material: Zinc alloy
Finish: Electroplating blue zinc
Wheel Size: $\Phi 27$ mm

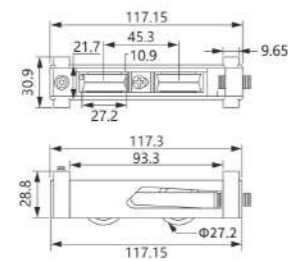

WW-77

Material: Iron
Wheel Size: $\Phi 25$ mm

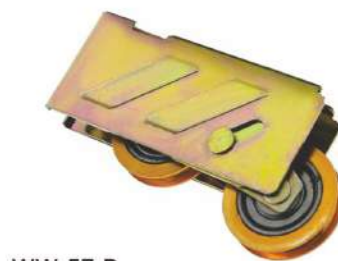
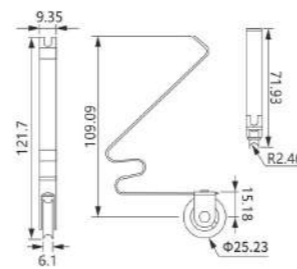

WW-57-D

Material: Iron
Finish: Iron plated color galvanized
Wheel Size: $\Phi 18$ mm



WW-56

Material: Aluminum
Wheel Size: $\Phi 21$ mm

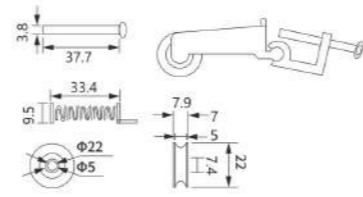

WW-38-1

Material: Iron wheel
Finish: Color zinc plating
Wheel Size: $\Phi 20$ mm

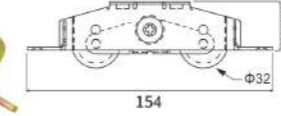

WW-38-2

Material: Nylon wheel
Finish: Color zinc plating
Wheel Size: $\Phi 20$ mm

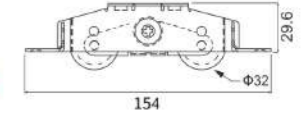

WW-40-1

Material: Iron
Finish: Color zinc plating
Wheel Size: $\Phi 20$ mm

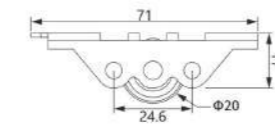

WW-99

Material: Iron
Finish: Color zinc plating
Wheel Size: $\Phi 20$ mm

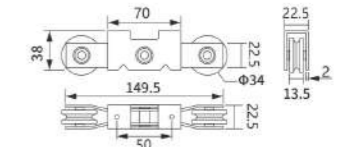

WW-40-2

Material: Iron
Finish: Color zinc plating
Wheel Size: $\Phi 20$ mm

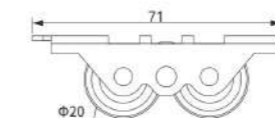

WW-100

Material: Iron
Finish: Color zinc plating
Wheel Size: $\Phi 20$ mm

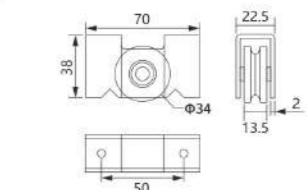

WW-18

Material: Iron
Finish: Iron plated color galvanized
Wheel Size: $\Phi 18$ mm

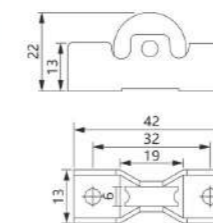

WW-101

Material: Iron
Finish: Color zinc plating
Wheel Size: $\Phi 20$ mm

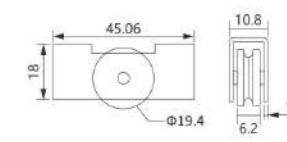

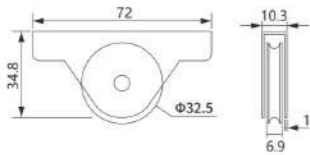

WW-104

Material: Iron
Finish: Color zinc plating
Wheel Size: Φ 20mm

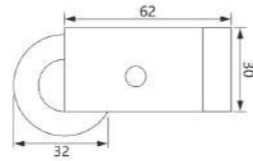

WW-10-3

Material: Aluminum shell + Iron wheel
Wheel Size: Φ 32mm

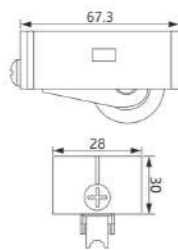

WW-90

Material: Iron
Finish: Electroplating white zinc
Wheel Size: Φ 41.5mm

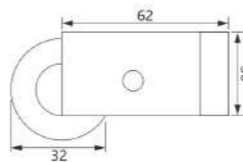

WW-10-4

Material: Aluminum shell + Nylon wheel
Wheel Size: Φ 32mm

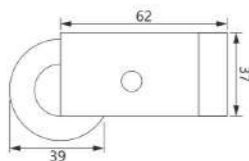

WW-10

Material: Aluminum shell + Nylon wheel
Wheel Size: Φ 39mm

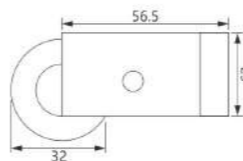

WW-10-5

Material: Aluminum shell + Nylon wheel
Wheel Size: Φ 32mm

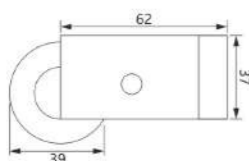

WW-10-1

Material: Aluminum shell + Brass wheel
Wheel Size: Φ 39mm

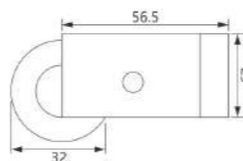

WW-10-6

Material: Aluminum shell + Nylon wheel
Wheel Size: Φ 32mm

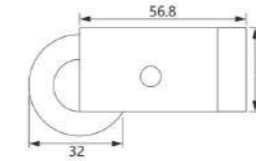

WW-10-7

Material: Aluminum shell + Nylon wheel
Wheel Size: Φ 32mm

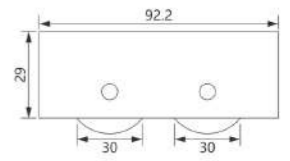

WW-58-D

Material: Aluminum
Wheel Size: Φ 30mm

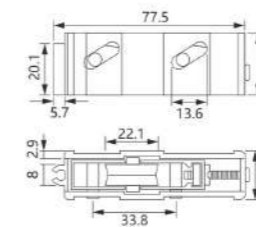

WW-37

Material: Aluminum
Wheel Size: Φ 19.5mm

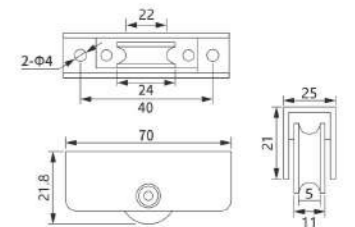

WW-06

Material: Aluminum
Finish: Iron plated color galvanized
Wheel Size: Φ 24mm

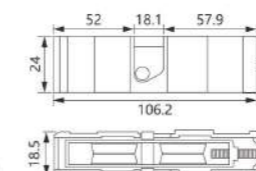

WW-37-D

Material: Aluminum
Wheel Size: Φ 19.5mm

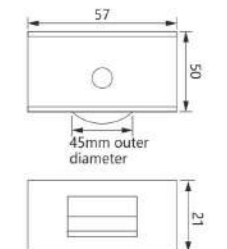

WW-01

Material: Aluminum
Wheel Size: Φ 32/45mm

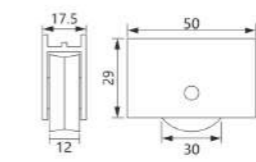

WW-58

Material: Aluminum
Wheel Size: Φ 30mm

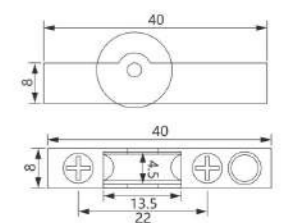

WW-24

Material: Zinc alloy
Finish: White zinc plated
Wheel Size: Φ 12mm

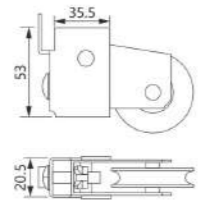

WW-02

Material: Iron
Finish: Iron plated color galvanized
Wheel Size: Φ 39mm

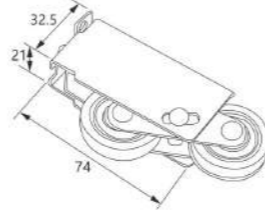

WW-27

Material: Iron
Finish: Color zinc plating
Wheel Size: Φ 40mm

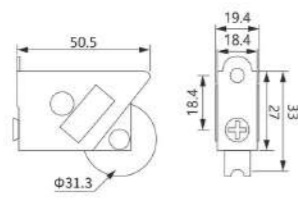

WW-63 (900)

Material: Iron
Finish: Nickel plated
Wheel: 626 bearing
Wheel Size: Φ 31.3mm

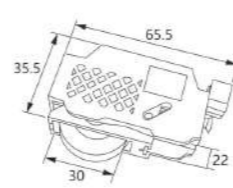

WW-35

Material: Plastic

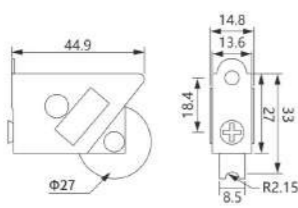

WW-66 (798)

Material: Iron
Finish: Nickel plated
Wheel: 698 straight core
Wheel Size: Φ 27mm

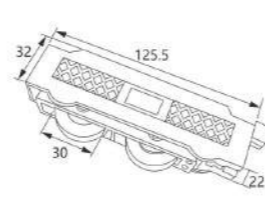

WW-35-1

Material: Plastic

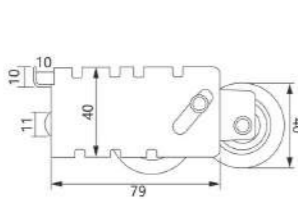

WW-05

Material: Iron
Finish: Iron plated color galvanized
Wheel Size: Φ 32/41mm

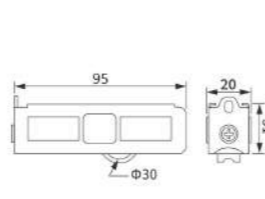

WW-61 (900)

Material: Iron
Wheel: 626 bearing
Wheel Size: Φ 32mm

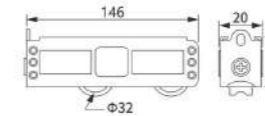

WW-62 (900)

Material: Plastic
Wheel: 626 bearing
Wheel Size: Φ 32mm

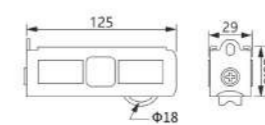

WW-64 (798)

Material: Plastic
Wheel: 696 bearing
Wheel Size: Φ 26mm

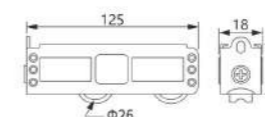

WW-65 (798)

Material: Plastic
Wheel: 696 bearing
Wheel Size: Φ 26mm

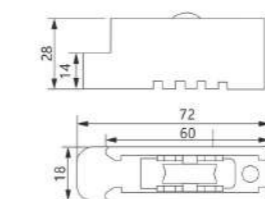

WW-21

Material: Plastic
Wheel Size: Φ 20mm

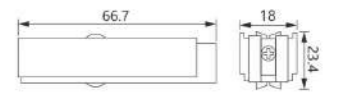

WW-21-1

Material: Plastic
Wheel Size: Φ 20mm

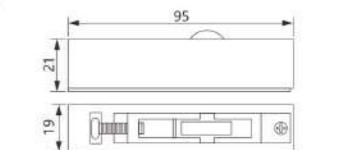

WW-21-2

Material: Plastic
Wheel Size: Φ 20mm

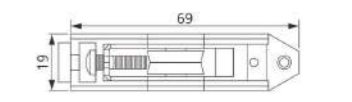

WW-21-3

Material: Plastic
Wheel Size: Φ 20mm

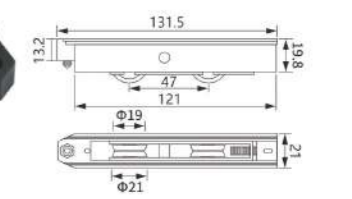

WW-23

Material: Plastic
Wheel Size: Φ 20.5mm

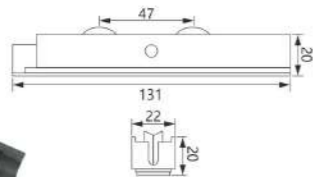

WW-89
Material: Plastic



WW-129
Material: Plastic



WW-23-S
Material: Plastic
Wheel Size: Φ 24mm

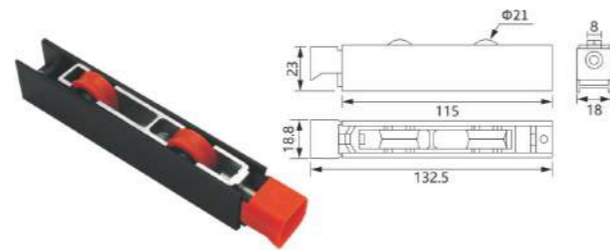

WW-95-D (R42)
Material: Iron
Finish: Color zinc plating
Wheel Size: Φ 21mm

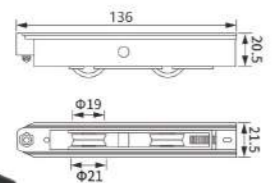

WW-23-2 (with spring)
Material: Plastic
Wheel Size: Φ 24mm

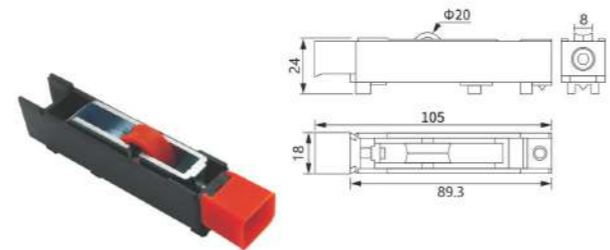

WW-95-D (R40)
Material: Iron
Finish: Color zinc plating
Wheel Size: Φ 20mm

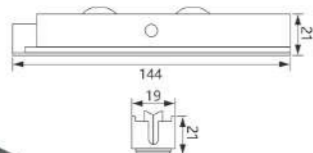

WW-88
Material: Plastic

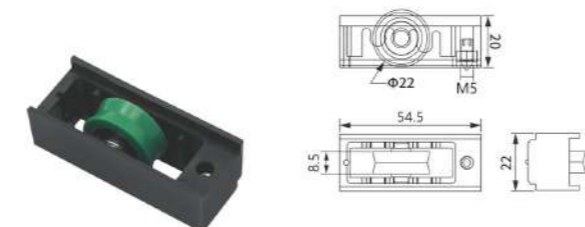

WW-48
Material: Plastic
Wheel Size: Φ 22mm



WW-184
Material: Nylon wheel
Wheel Size: Φ 21mm



WW-185
Material: Nylon wheel
Wheel Size: Φ 21mm

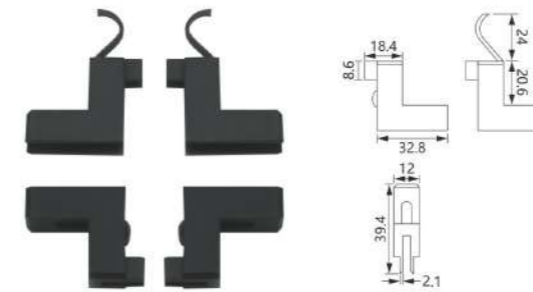

WW-87 (EBM)
Material: Plastic

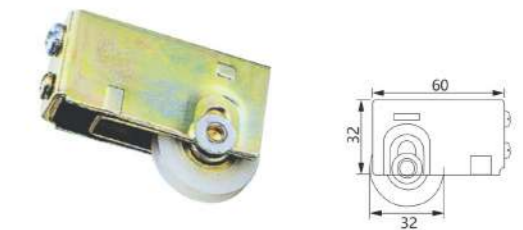

WW-09
Material: Iron
Finish: Iron plated color galvanized
Wheel Size: Φ 32mm



WW-16
Material: Iron
Finish: Nickel plated
Wheel Size: Φ 20mm



WW-29
Material: Stainless Steel 304
Wheel Size: Φ 67mm



WW-32
Material: Iron
Finish: Iron plated color galvanized
Wheel Size: Φ 29.6mm



WW-70
Material: Aluminum
Wheel Size: Φ 34.8mm



WW-71
Material: Aluminum + SS304
Wheel Size: Φ 35mm

Aluminium Hardware Sliding Door Hardware

- Security defender
- Easy to install
- Durable and economic
- Available in aluminium alloy material

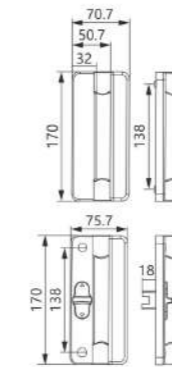

SDH-01
Material: Aluminum alloy/Zinc alloy
Finish: Powder coating, Oil injection
Colour: Black, White, Silver

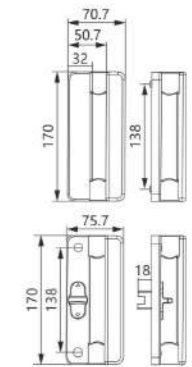

SDH-04 (with keys)
Material: Aluminum alloy/Zinc alloy
Finish: Powder coating, Oil injection
Colour: Black, White, Silver

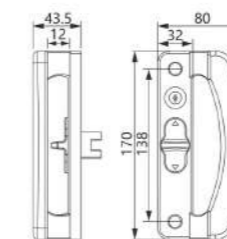

SDH-02
Material: Aluminum alloy/Zinc alloy
Finish: Powder coating, Oil injection
Colour: Black, White, Silver

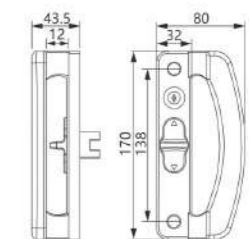

SDH-05 (with keys)
Material: Aluminum alloy/Zinc alloy
Finish: Powder coating, Oil injection
Colour: Black, White, Silver



SDH-03 (with keys)
Material: Aluminum alloy + Zinc alloy
Finish: Powder coating, Oil injection
Colour: Black, White, Silver

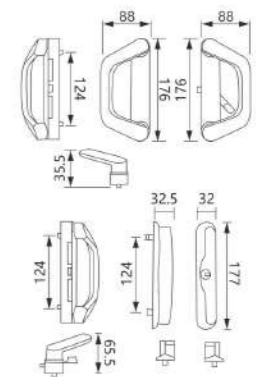

SDH-06
Material: Aluminum alloy + Zinc alloy
Finish: Powder coating, Oil injection
Colour: Black, White, Silver

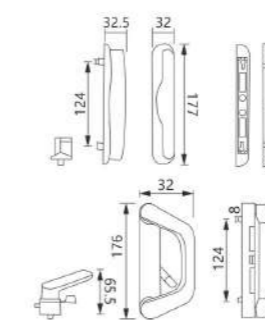

SDH-14
Material: Aluminum alloy/Zinc alloy
Finish: Powder coating, Oil injection
Colour: Black, White, Silver

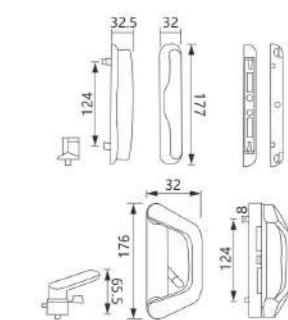

SDH-14-1 (with keys)
Material: Aluminum alloy + Zinc alloy
Finish: Powder coating, Oil injection
Colour: Black, White, Silver

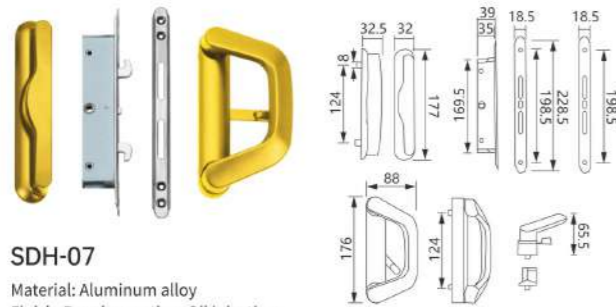

SDH-07
Material: Aluminum alloy
Finish: Powder coating, Oil injection
Colour: Black, White, Silver

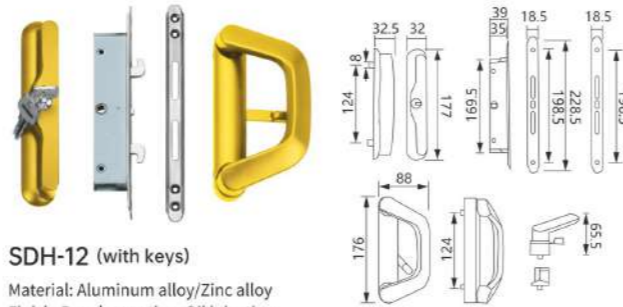

SDH-12 (with keys)
Material: Aluminum alloy/Zinc alloy
Finish: Powder coating, Oil injection
Colour: Black, White, Silver

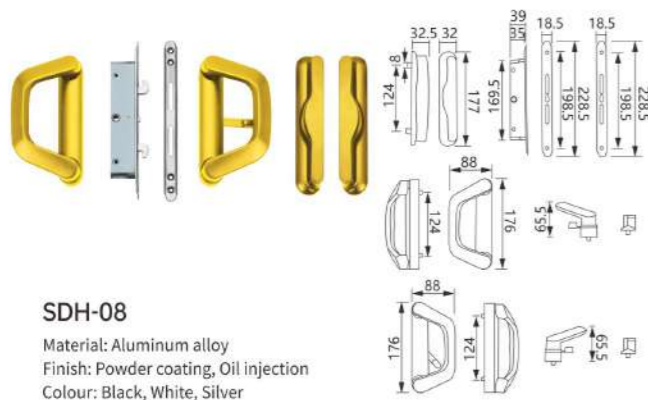

SDH-08
Material: Aluminum alloy
Finish: Powder coating, Oil injection
Colour: Black, White, Silver

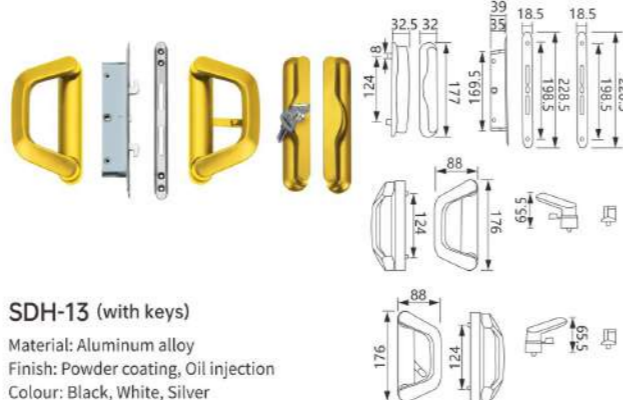

SDH-13 (with keys)
Material: Aluminum alloy
Finish: Powder coating, Oil injection
Colour: Black, White, Silver



SDH-09
Material: Aluminum alloy + Zinc alloy
Finish: Powder coating, Oil injection
Colour: Black, White, Silver

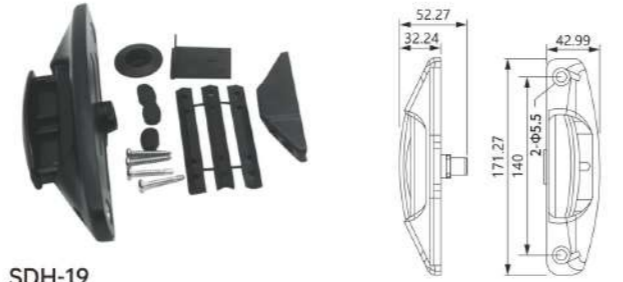

SDH-19
Material: Aluminum alloy
Finish: Powder coating, Oil injection
Colour: Black, White, Silver

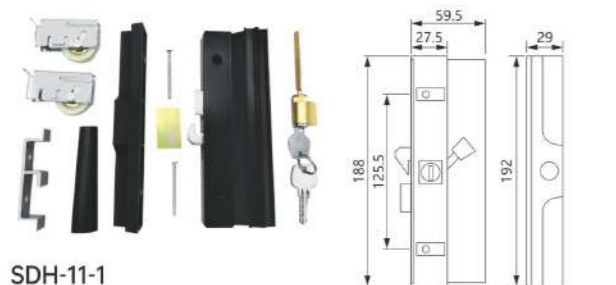

SDH-11-1
Material: Aluminum + Plastic
Finish: Powder coating, Oil injection
Colour: Black, White, Silver



SDH-Mini Patio Door Handle
Material: Aluminum + Plastic
Finish: Powder coating, Oil injection
Colour: Black, White, Silver



SDH-10
Material: Zinc alloy
Finish: Powder coating, Oil injection
Colour: Black, White, Silver



SDH-15-1 (with keys)
Material: Zinc alloy
Finish: Powder coating, Oil injection
Colour: Black, White, Silver



SDH-10-1
Material: Zinc alloy
Finish: Powder coating, Oil injection
Colour: Black, White, Silver



SDH-27
Material: Aluminum alloy
Finish: Powder coating, Oil injection
Colour: Black, White, Silver

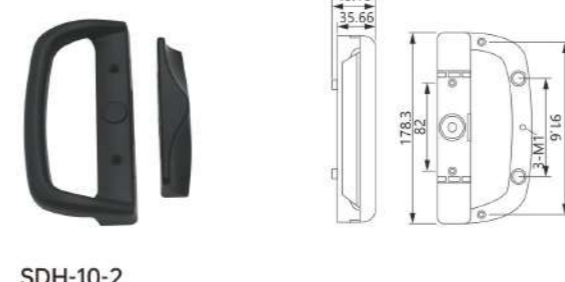

SDH-10-2
Material: Zinc alloy
Finish: Powder coating, Oil injection
Colour: Black, White, Silver

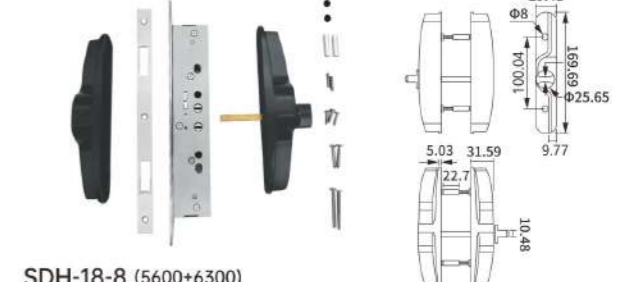

SDH-18-8 (5600+6300)
Material: Aluminum alloy
Finish: Powder coating, Oil injection
Colour: Black, White, Silver



SDH-15
Material: Zinc alloy
Finish: Powder coating, Oil injection
Colour: Black, White, Silver

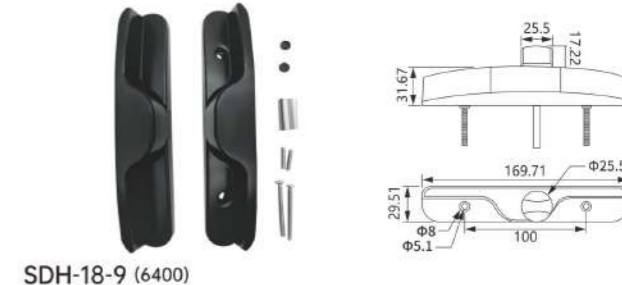

SDH-18-9 (6400)
Material: Aluminum alloy
Finish: Powder coating, Oil injection
Colour: Black, White, Silver



SDH-18 (6900)
Material: Aluminum alloy
Finish: Powder coating, Oil injection
Colour: Black, White, Silver

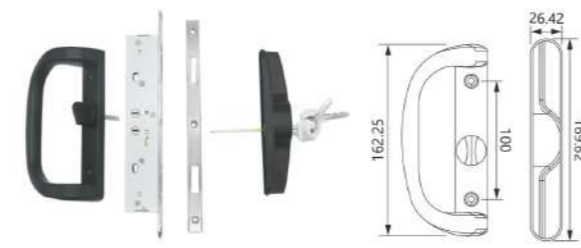

SDH-18-1 (605) (with keys)
Material: Aluminum alloy
Finish: Powder coating, Oil injection
Colour: Black, White, Silver



SDH-29-1
Material: Aluminum alloy
Finish: Powder coating, Oil injection
Colour: Black, White, Silver



SDH-34
Material: Aluminum alloy
Finish: Powder coating, Oil injection
Colour: Black, White, Silver

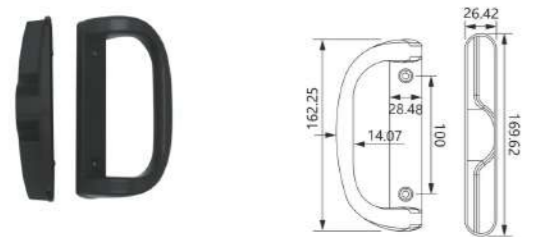

SDH-18-3 (606)
Material: Aluminum alloy
Finish: Powder coating, Oil injection
Colour: Black, White, Silver



SDH-18-4 (601) (with keys)
Material: Aluminum alloy
Finish: Powder coating, Oil injection
Colour: Black, White, Silver



SDH-29
Material: Aluminum alloy
Finish: Powder coating, Oil injection
Colour: Black, White, Silver



SDH-33
Material: Aluminum alloy
Finish: Powder coating, Oil injection
Colour: Black, White, Silver

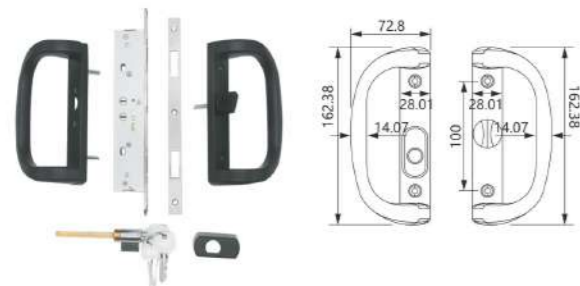

SDH-18-5 (602) (with keys)
Material: Aluminum alloy
Finish: Powder coating, Oil injection
Colour: Black, White, Silver

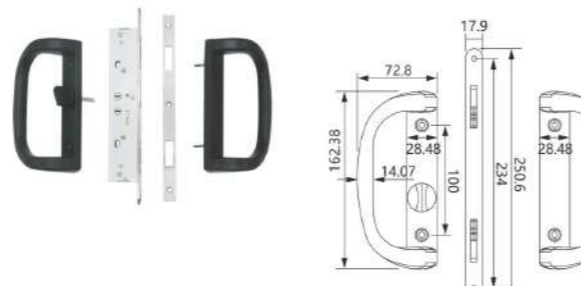

SDH-18-6 (603)
Material: Aluminum alloy
Finish: Powder coating, Oil injection
Colour: Black, White, Silver



SDH-30
Material: Aluminum alloy
Finish: Powder coating, Oil injection
Colour: Black, White, Silver



SDH-35
Material: Aluminum
Finish: Powder coating, Oil injection
Colour: Black, White, Silver

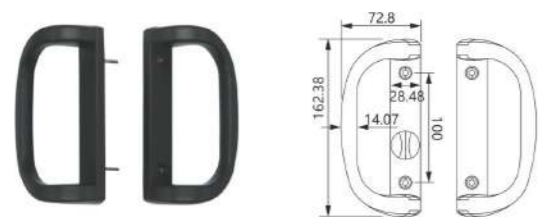

SDH-18-7 (604)
Material: Aluminum alloy
Finish: Powder coating, Oil injection
Colour: Black, White, Silver

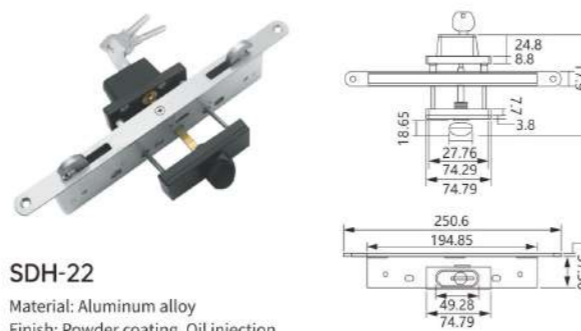

SDH-22
Material: Aluminum alloy
Finish: Powder coating, Oil injection
Colour: Black, White, Silver

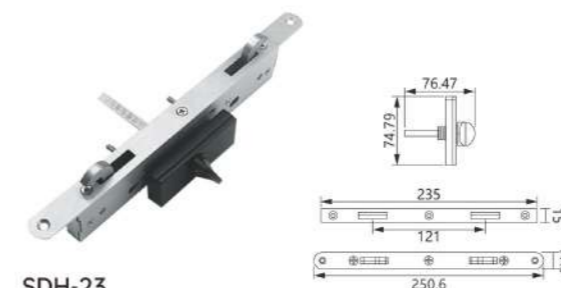

SDH-23
Material: Aluminum alloy
Finish: Powder coating, Oil injection
Colour: Black, White, Silver

Patio door cylinder





CF-01
Material: Aluminum alloy



CF-55-5503
Material: Aluminum alloy



CF-50-3516
Material: Aluminum alloy



CF-53-A011
Material: Aluminum alloy

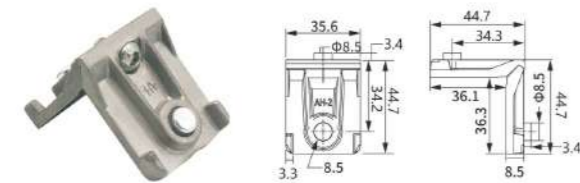

CF-01-2
Material: Aluminum alloy

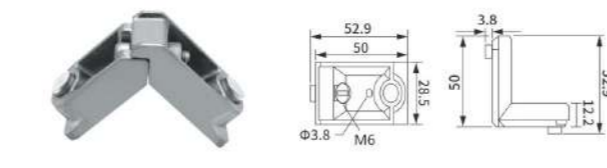

CF-16
Material: Aluminum alloy



CF-51-0447
Material: Aluminum alloy



CF-17
Material: Aluminum alloy

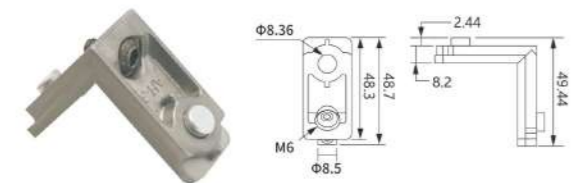

CF-01-3
Material: Aluminum alloy



CF-48-0426
Material: Aluminum alloy



CF-47-0389
Material: Aluminum alloy

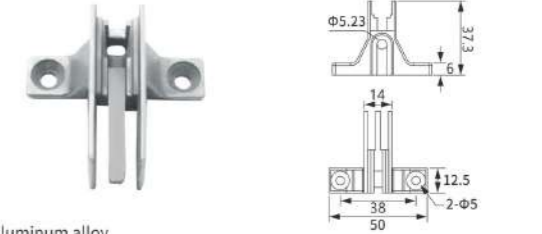

CF-20
Material: Aluminum alloy



CF-01-4
Material: Aluminum alloy



CF-6-0444
Material: Aluminum alloy



CF-52-0410
Material: Aluminum alloy



CF-22
Material: Aluminum



CF-02
Material: Aluminum alloy



CF-54-0461
Material: Aluminum alloy



CF-45
Material: Aluminum alloy



CF-56
Material: Aluminum



CF-43
Material: Aluminum alloy



CF-49-0376
Material: Aluminum alloy



CF-44-0361
Material: Aluminum alloy



CF-57
Material: Aluminum



CF-23
Material: Aluminum



CF-25
Material: Aluminum

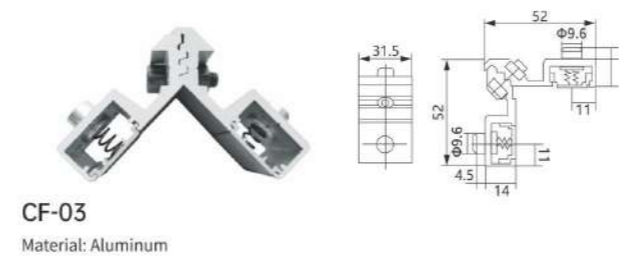

CF-03
Material: Aluminum

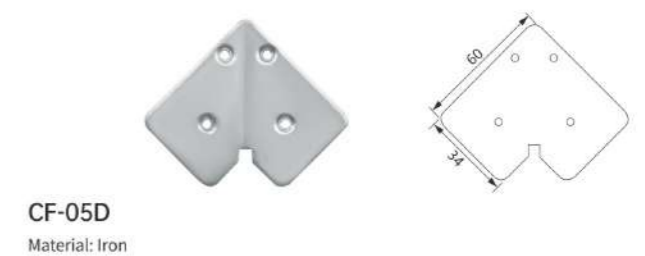

CF-05D
Material: Iron



CF-24
Material: Aluminum



CF-26
Material: Aluminum



CF-03-2
Material: Aluminum

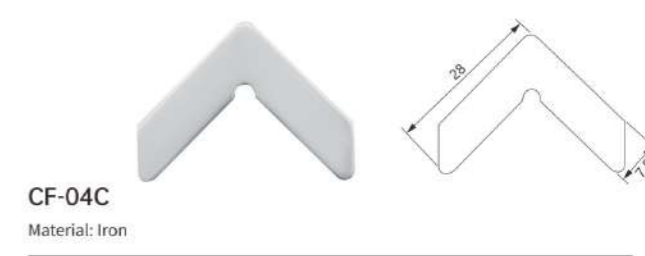

CF-04C
Material: Iron

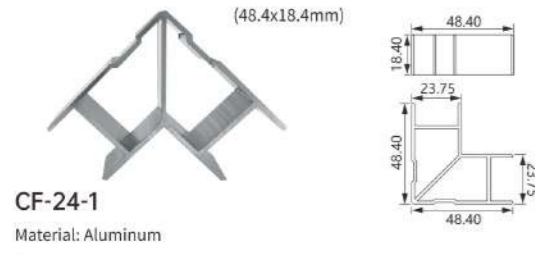

CF-24-1
Material: Aluminum



CF-27
Material: Aluminum



CF-03-3
Material: Aluminum

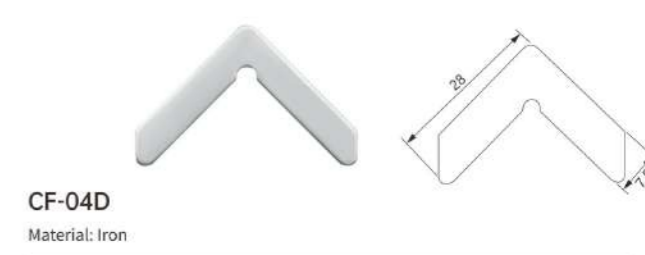

CF-04D
Material: Iron

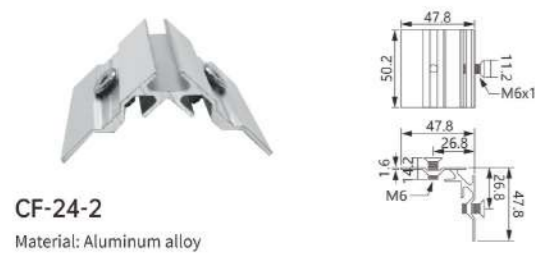

CF-24-2
Material: Aluminum alloy



CF-39 (37/42mm)
Material: Aluminum



CF-03-4
Material: Aluminum

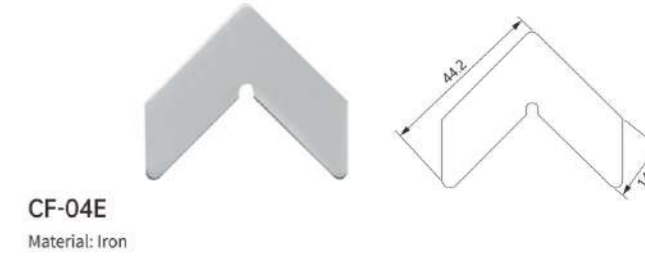

CF-04E
Material: Iron

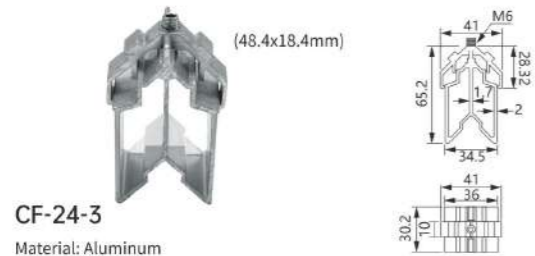

CF-24-3
Material: Aluminum



CF-58
Material: Aluminum

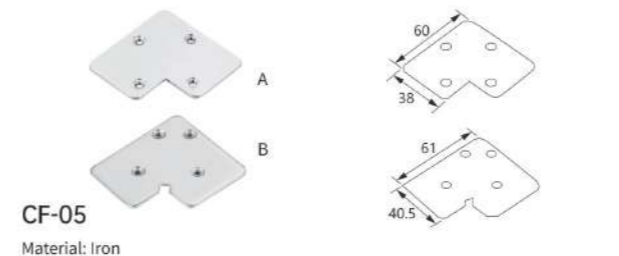

CF-05
Material: Iron



CF-41
Material: Iron



CF-06
Material: Aluminum
Size available: 23/23.5/24/25/28.5/30mm

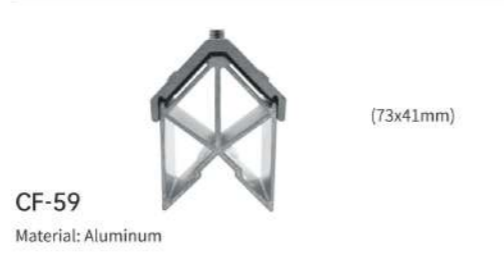

CF-59
Material: Aluminum

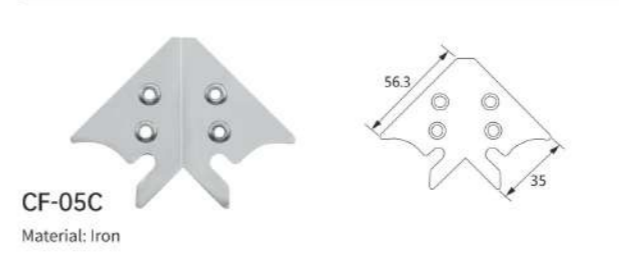

CF-05C
Material: Iron



CF-41-2
Material: Iron

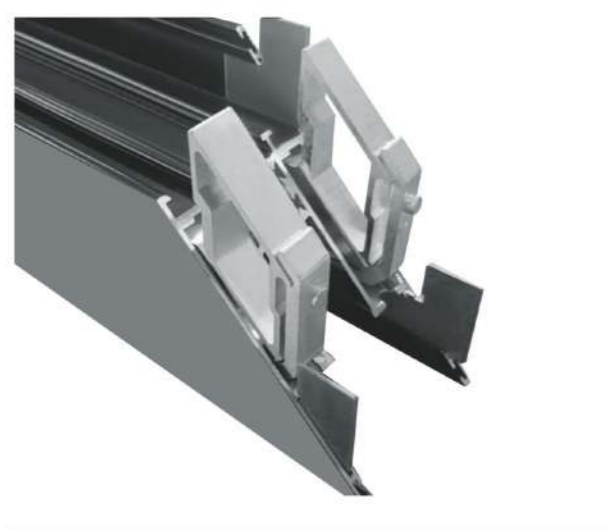
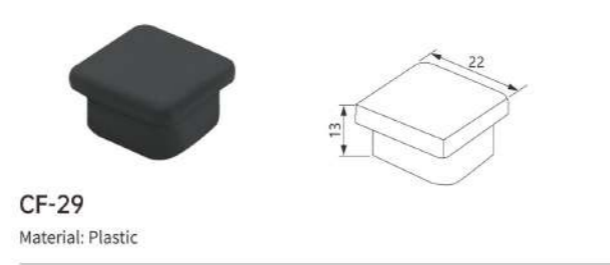
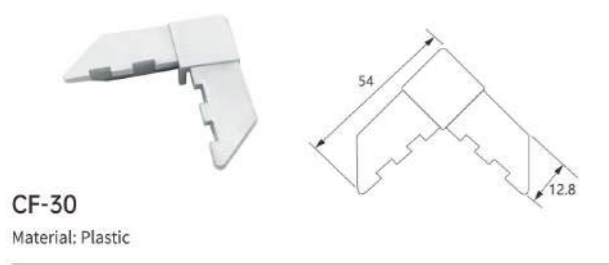
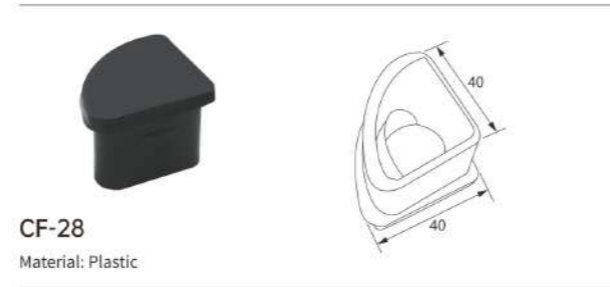
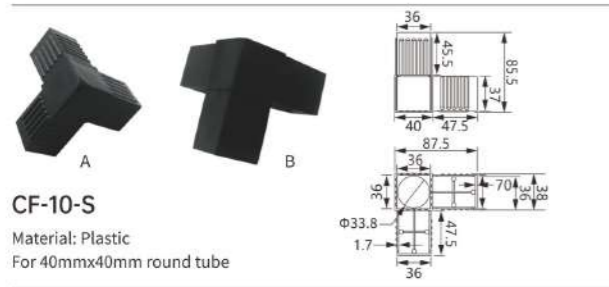
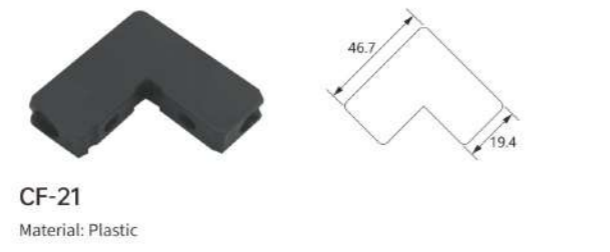
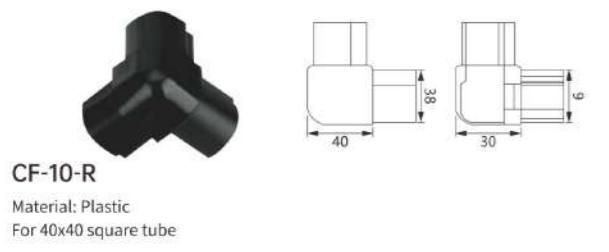
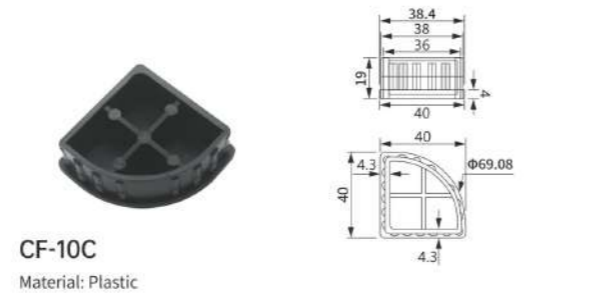
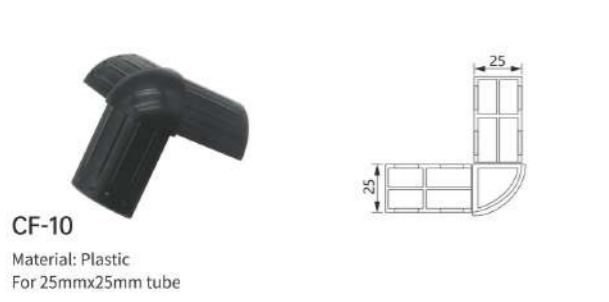

WATERPROOF WEATHER STRIP
Features:BY Multi-channel silicone oil treatment, better waterproofeffect ,adding anti-aging ingredients,not easy to powder aging.Wool filament after special processing, elastic, more than50,000 times of friction withoutdeformation, durable wear resistance, better resilience.



PVC OR FABRIC FINNED WEATHER FOR DOORS AND WINDOWS
Features:Waterproof and sound-proof, 5-10 timesbetter in the sealing performance.Reducefriction, durable use, energy saving andenvironmental protect and higher efficient.



PVC OR FABRIC FINNED WEATHER FOR DOORS AND WINDOWS
Features:Waterproof and sound-proof, 5-10 timesbetter in the sealing performance.Reducefriction, durable use, energy saving andenvironmental protect and higher efficient.



SUPER HIGH & STRAIGHT WEATHER FOR SCREEN DOORS SERIES
Features:It has the characteristics of mosquito repellent, super high, goodelasticity, super straight, wear-resistant, waterproof and so on.

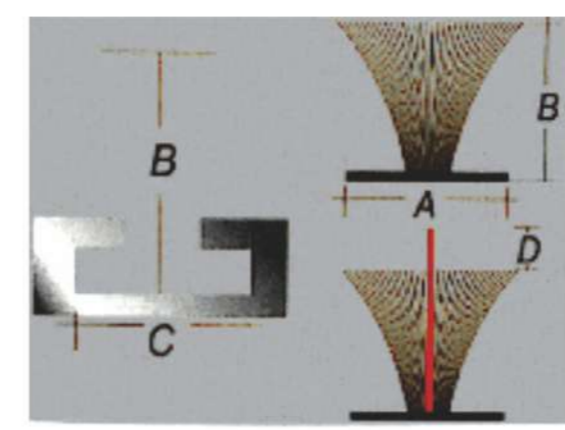

A (Base width)	B (Pile height)	C (Trough width)	D (Fin height difference)
6.8±0.1mm	3-25mm	70±0.1mm	-0.5-2.0mm
5.8±0.1mm	3-25mm	6.0±0.1mm	-0.5-2.0mm
4.8±0.1mm	3-25mm	5.0±0.1mm	-0.5-2.0mm
6.5±0.1mm	3-25mm	6.7±0.1mm	-0.5-2.0mm
5.5±0.1mm	3-25mm	5.7±0.1mm	-0.5-2.0mm
4.5±0.1mm	3-25mm	4.7±0.1mm	-0.5-2.0mm

All kinds of Non-Standard weather strips is available

Material: EPDM, PVC, RPVC Different Size And Shape Is Available



RS-1



RS-5-A



RS-5-B

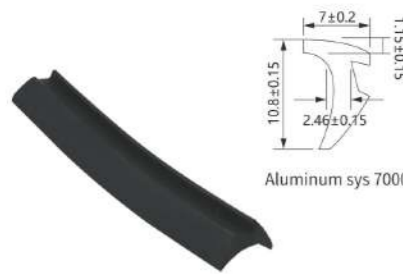

RS-5-C

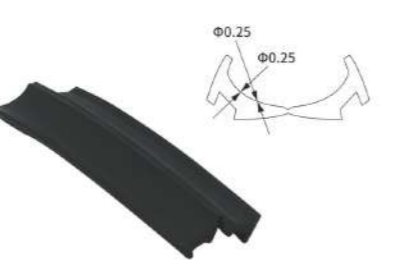

RS-5-D



RS-6



RS-8



RS-9



RS-9-B



RS-9-C



RS-9-D



RS-9-E



RS-9-F

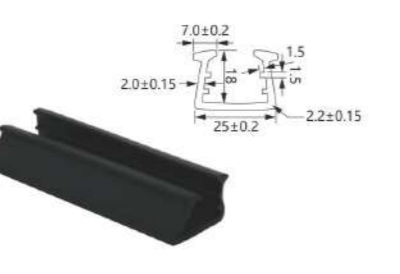

RS-9-G

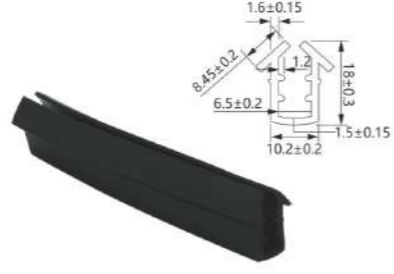

RS-9-H



RS-9-I



RS-9-J



RS-10-A



RS-10-B



RS-10-C



RS-11

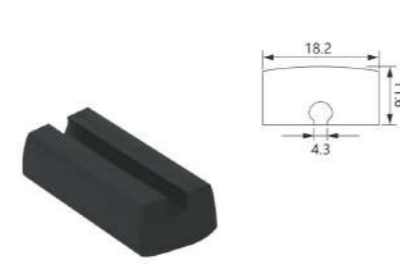

RS-12

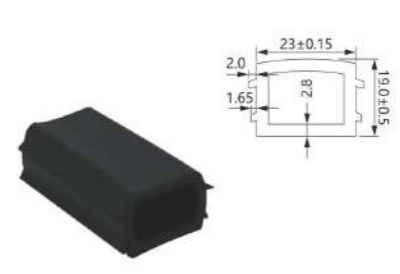

RS-13

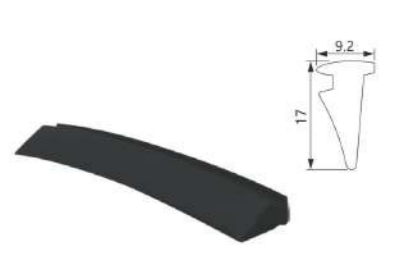

RS-14



RS-15



RS-16

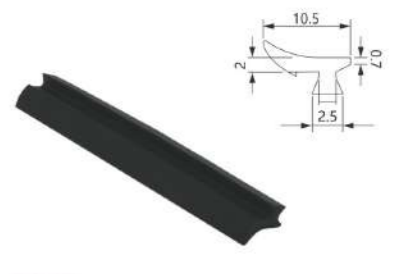

RS-17



RS-18



RS-19

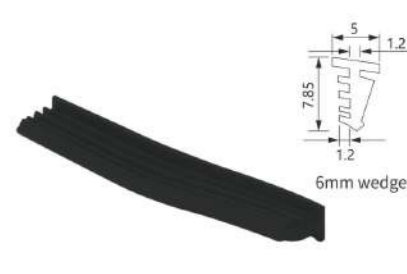

RS-19-B



RS-20

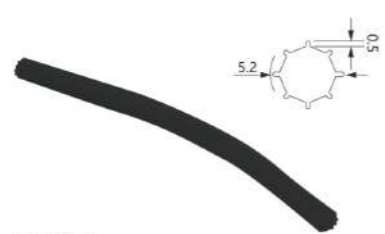

RS-21-A



RS-21-B



RS-33-B



RS-33-C



RS-34-A



RS-22



RS-23



RS-24



RS-34-B



Package Detail:



Package Detail:



RS-25



RS-26



RS-27



P-92(Plastic gasket)



P-65(Plastic gasket)



RS-28



RS-29



RS-30



M-100(Plastic gasket)



Traditional gasket



RS-31

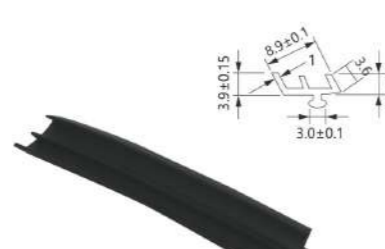

RS-32

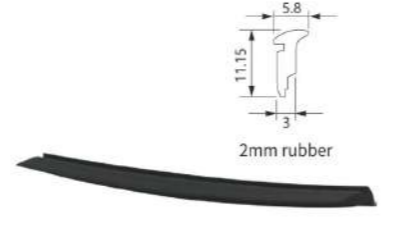

RS-33-A

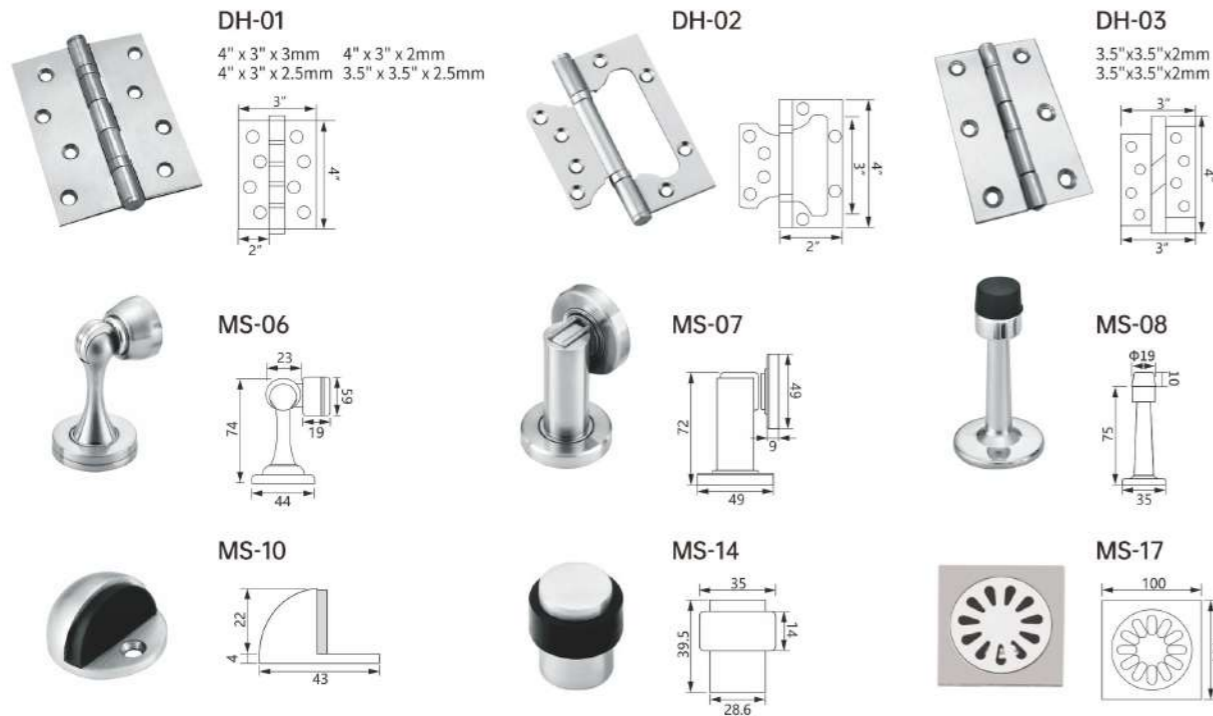

Pan head
Material: Aluminium + Iron
Finish: Zinc white plated

Size	Size	Size
3.2x6	4x8	5x8
3.2x8	4x10	5x10
3.2x10	4x12	5x12
3.2x12	4x14	5x14(15)
3.2x14	4x16	5x16
3.2x16	4x18	5x18
	4x20	5x20
		5x25

Countersunk head
Material: Aluminium + Iron
Finish: Zinc white plated

Size	Size	Size
3.2x6	4x8	5x8
3.2x8	4x10	5x10
3.2x10	4x12	5x12
3.2x12	4x14	5x14(15)
3.2x14	4x16	5x16
3.2x16	4x18	5x18
	4x20	5x20
		5x25



2/4/6/8 Roll/Carton (According to the actual size and your requirements)



Material	PE
Thickness	10micron-80micron
Length	200-4500mm
Width	35-1500mm
Core Dimension	1"-3"
Core Length	25mm-76mm
Core Weight	80g-1000g
Color	Clear
Pack Qty	4/6/12ROLL
Size	Special size can be made according to customer's requirement



Normal size for order: W6 x T6 x 10m/roll. W8 x T6 x 10m/roll. W10 x T6 x 10m/roll. W12 x T2 x 10m/roll. W12 x T6 x 10m/roll

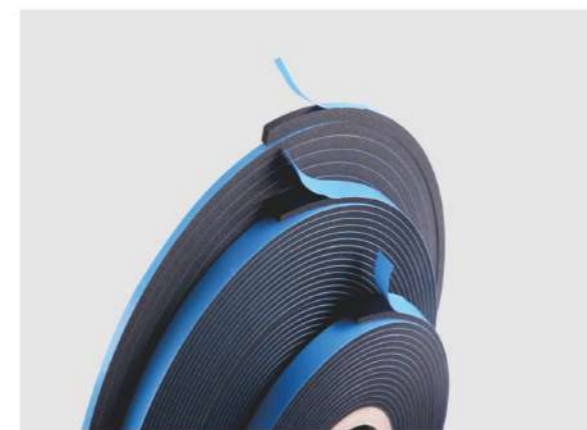

Product Name	Double Sided Structural Adhesive Foam Tape for glass windows
Material	PE FOAM
Color	Black
Adhesive	Acrylic
Thickness	0.4mm to 12mm
Length	50m or customized
Width	3mm or customized
Feature	Waterproof

- Shockproof Buffer
- Sound Insulation
- Heat Insulation
- Moisture Proof



LS-1

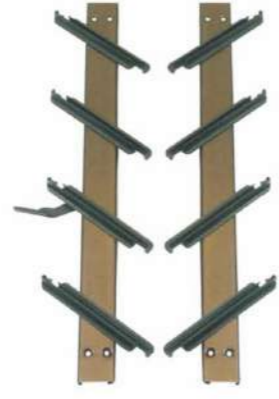

LS-2



LS-3

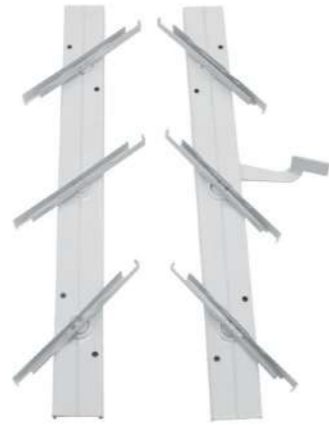

LS-4



LS-5

Normal configuration table		
Leaf	Length(cm)	Remark(handle)
3	29	one
4	37	one
5	46	one
6	55	one
7	64	one
8	73	two
9	82	two
10	91	three
11	100	three
12	109	three
13	118	three
14	127	three
15	136	three

NOTES

Area with horizontal dashed lines for notes.